

NEUROSCIENCE

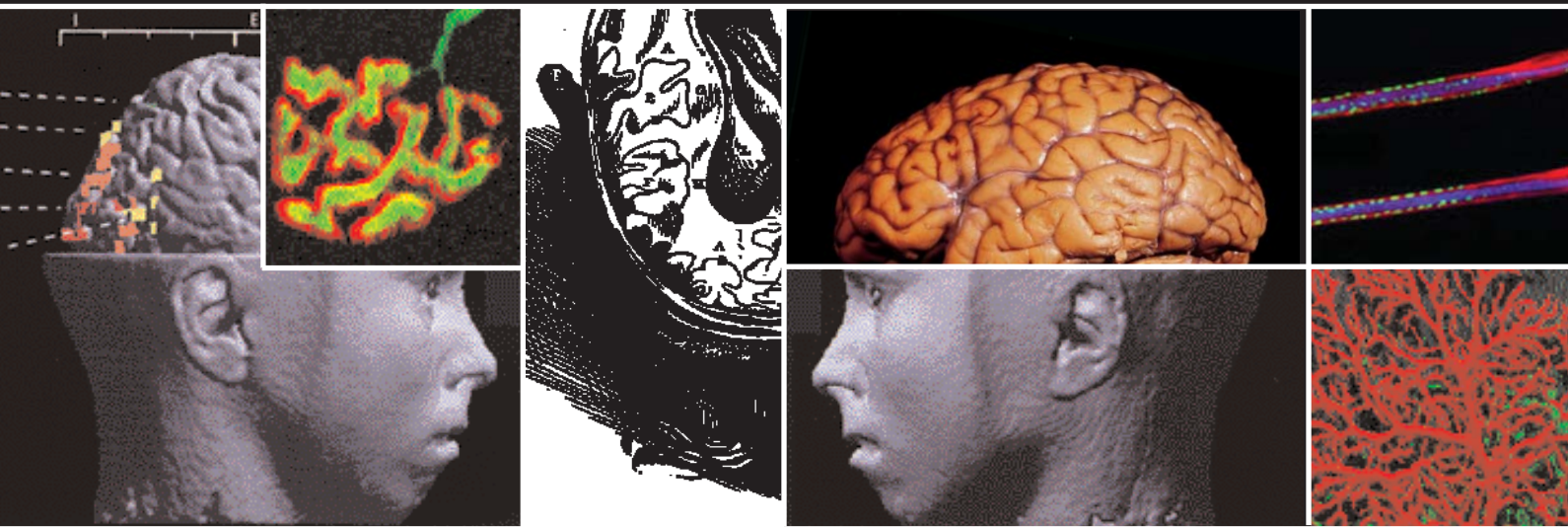

SCIENCE OF THE BRAIN

AN INTRODUCTION FOR YOUNG STUDENTS

British Neuroscience Association
European Dana Alliance for the Brain

Neuroscience: the Science of the Brain

1	The Nervous System	P2
2	Neurons and the Action Potential	P4
3	Chemical Messengers	P7
4	Drugs and the Brain	P9
5	Touch and Pain	P11
6	Vision	P14
7	Movement	P19
8	The Developing Nervous System	P22
9	Dyslexia	P25
10	Plasticity	P27
11	Learning and Memory	P30
12	Stress	P35
13	The Immune System	P37
14	Sleep	P39
15	Brain Imaging	P41
16	Artificial Brains and Neural Networks	P44
17	When things go wrong	P47
18	Neuroethics	P52
19	Training and Careers	P54
20	Further Reading and Acknowledgements	P56



Inside our heads, weighing about 1.5 kg, is an astonishing living organ consisting of billions of tiny cells. It enables us to sense the world around us, to think and to talk. The human brain is the most complex organ of the body, and arguably the most complex thing on earth. This booklet is an introduction for young students.

In this booklet, we describe what we know about how the brain works and how much there still is to learn. Its study involves scientists and medical doctors from many disciplines, ranging from molecular biology through to experimental psychology, as well as the disciplines of anatomy, physiology and pharmacology. Their shared interest has led to a new discipline called **neuroscience - the science of the brain**.

The brain described in our booklet can do a lot but not everything. It has nerve cells - its building blocks - and these are connected together in networks. These networks are in a constant state of electrical and chemical activity. The brain we describe can see and feel. It can sense pain and its chemical tricks help control the uncomfortable effects of pain. It has several areas devoted to co-ordinating our movements to carry out sophisticated actions. A brain that can do these and many other things doesn't come fully formed: it develops gradually and we describe some of the key genes involved. When one or more of these genes goes wrong, various conditions develop, such as dyslexia. There are similarities between how the brain develops and the mechanisms responsible for altering the connections between nerve cells later on - a process called neuronal plasticity. Plasticity is thought to underlie learning and remembering. Our booklet's brain can remember telephone numbers and what you did last Christmas. Regrettably, particularly for a brain that remembers family holidays, it doesn't eat or drink. So it's all a bit limited. But it does get stressed, as we all do, and we touch on some of the hormonal and molecular mechanisms that can lead to extreme anxiety - such as many of us feel in the run-up to examinations. That's a time when sleep is important, so we let it have the rest it needs. Sadly, it can also become diseased and injured.

New techniques, such as special electrodes that can touch the surface of cells, optical imaging, human brain scanning machines, and silicon chips containing artificial brain circuits are all changing the face of modern neuroscience. We introduce these to you and touch on some of the ethical issues and social implications emerging from brain research.



**The European
Dana Alliance
for the Brain**

This booklet was prepared and edited on behalf of the British Neuroscience Association and the European Dana Alliance for the Brain by Richard Morris (University of Edinburgh) and Marianne Fillenz (University of Oxford). The graphic design was by Jane Grainger (Grainger Dunsmore Design Studio, Edinburgh). We are grateful for contributions from our colleagues in the Division of Neuroscience, particularly Victoria Gill, and others in the neuroscience community in Edinburgh. We also thank members of the University Department of Physiology in Oxford, particularly Colin Blakemore, and helpful colleagues in other institutions. Their names are listed on the back page.

The **British Neuroscience Association (BNA)** is the professional body in the United Kingdom that represents neuroscientists and is dedicated towards a better understanding of the nervous system in health and disease. Its members range from established scientists holding positions in Universities and Research Institutes through to postgraduate students. The BNA's annual meetings, generally held in the spring, provide a forum for the presentation of the latest research. Numerous local groups around the country hold frequent seminars and these groups often organise activities with the general public such as school visits and exhibitions in local museums. See <http://www.bna.org.uk/> for further information.

The goal of The **European Dana Alliance for the Brain (EDAB)** is to inform the general public and decision makers about the importance of brain research. EDAB aims to advance knowledge about the personal and public benefits of neuroscience and to disseminate information on the brain, in health and disease, in an accessible and relevant way. Neurological and psychiatric disorders affect millions of people of all ages and make a severe impact on the national economy. To help overcome these problems, in 1997, 70 leading European neuroscientists signed a Declaration of Achievable Research Goals and made a commitment to increase awareness of brain disorders and of the importance of neuroscience. Since then, many others have been elected, representing 24 European countries. EDAB has more than 125 members. See <http://www.edab.net/> for further information.

Published by The British Neuroscience Association
The Sherrington Buildings
Ashton Street
Liverpool
L69 3GE
UK
Copyright British Neuroscience Association 2003

This book is in copyright. Subject to statutory exception and the provisions of relevant collective licensing agreements, no reproduction of any part may take place without the written permission of The British Neuroscience Association

First Published 2003
ISBN: 0-9545204-0-8

The images on this page are of neurons of the cerebral cortex visualised using special dyes inserted into the adjacent cells.



The Nervous System

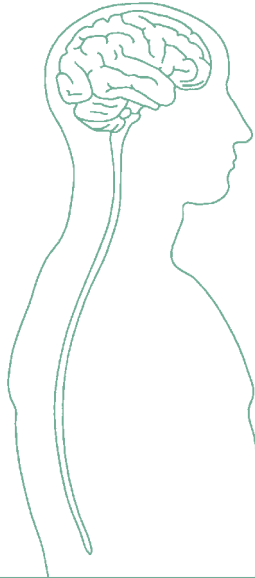
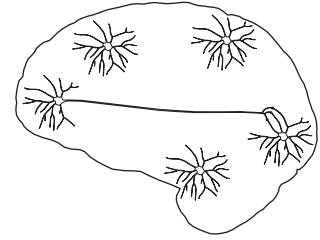

Human central nervous system showing the brain and spinal cord

Basic structure

The nervous system consists of the brain, spinal cord and peripheral nerves. It is made up of nerve cells, called neurons, and supporting cells called glial cells.

There are three main kinds of neurons. **Sensory neurons** are coupled to receptors specialised to detect and respond to different attributes of the internal and external environment. The receptors sensitive to changes in light, sound, mechanical and chemical stimuli subserve the sensory modalities of vision, hearing, touch, smell and taste.

When mechanical, thermal or chemical stimuli to the skin exceed a certain intensity, they can cause tissue damage and a special set of receptors called nociceptors are activated; these give rise both to protective reflexes and to the sensation of pain (see chapter 5 on Touch and Pain).

Motor neurons, which control the activity of muscles, are responsible for all forms of behaviour including speech. Interposed between sensory and motor neurons are interneurons. These are by far the most numerous (in the human brain). **Interneurons** mediate simple reflexes as well as being responsible for the highest functions of the brain. **Glial cells**, long thought to have a purely supporting function to the neurons, are now known to make an important contribution to the development of the nervous system and to its function in the adult brain. While much more numerous, they do not transmit information in the way that neurons do.

Neurons have an architecture that consists of a **cell body** and two sets of additional compartments called '**processes**'. One of these sets are called axons; their job is to transmit information from the neuron on to others to which it is connected. The other set are called **dendrites** - their job is to receive the information being transmitted by the axons of other neurons. Both of these processes participate in the specialised contacts called **synapses** (see the Chapters 2&3 on Action Potential and Chemical Messengers). Neurons are organised into complex chains and networks that are the pathways through which information in the nervous system is transmitted.

The brain and spinal cord are connected to sensory receptors and muscles through long axons that make up the peripheral nerves. The **spinal cord** has two functions: it is the seat of simple reflexes such as the knee jerk and the rapid withdrawal of a limb from a hot object or a pinprick, as well as more complex reflexes, and it forms a highway between the body and the brain for information travelling in both directions.

These basic structures of the nervous system are the same in all vertebrates. What distinguishes the human brain is its large size in relation to body size. This is due to an enormous increase in the number of interneurons over the course of evolution, providing humans with an immeasurably wide choice of reactions to the environment.

Anatomy of the Brain

The brain consists of the **brain stem** and the **cerebral hemispheres**.

The brain stem is divided into hind-brain, mid-brain and a 'between-brain' called the diencephalon. The hind-brain is an extension of the spinal cord. It contains networks of neurons that constitute centres for the control of vital functions such as breathing and blood pressure. Within these are networks of neurons whose activity controls these functions. Arising from the roof of the hind-brain is the **cerebellum**, which plays an absolutely central role in the control and timing of movements (See Chapters on Movement and Dyslexia).

The midbrain contains groups of neurons, each of which seem to use predominantly a particular type of chemical messenger, but all of which project up to cerebral hemispheres. It is thought that these can modulate the activity of neurons in the higher centres of the brain

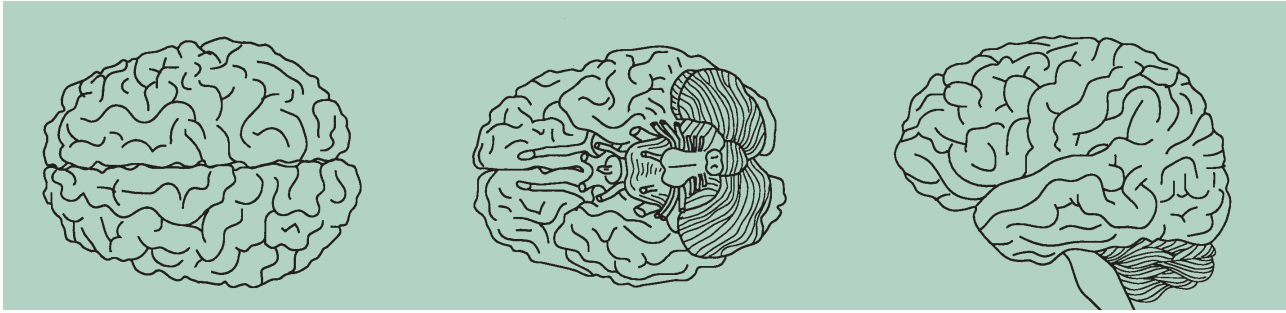

The human brain seen from above, below and the side.

to mediate such functions as sleep, attention or reward. The diencephalon is divided into two very different areas called the **thalamus** and the **hypothalamus**: The thalamus relays impulses from all sensory systems to the cerebral cortex, which in turn sends messages back to the thalamus. This back-and-forward aspect of connectivity in the brain is intriguing - information doesn't just travel one way. The hypothalamus controls functions such as eating and drinking, and it also regulates the release of hormones involved in sexual functions.

The **cerebral hemispheres** consist of a core, the **basal ganglia**, and an extensive but thin surrounding sheet of neurons making up the grey matter of the cerebral cortex. The basal ganglia play a central role in the initiation and control of movement. (See Chapter 7 on Movement). Packed into the limited space of the skull, the cerebral cortex is thrown into folds that weave in and out to enable a much larger surface area for the sheet of neurons than would otherwise be possible. This cortical tissue is the most highly developed area of the brain in humans - four times bigger than in gorillas. It is divided into a large number of discrete areas, each distinguishable in terms of its layers and connections. The functions of many of these areas are known - such as the visual, auditory, and olfactory areas, the sensory areas receiving from the skin (called the **somaesthetic areas**) and various motor areas. The pathways from the sensory receptors to the cortex and from cortex to the muscles cross over from one side to the other. Thus movements of the right side of the body are controlled by the left side of the cortex (and vice versa). Similarly, the left half of the body sends sensory signals to the right hemisphere such that, for example, sounds in the left ear mainly reach the right cortex. However, the two halves of the brain do not work in isolation - for the left and right cerebral cortex are connected by a large fibre tract called the **corpus callosum**.

The cerebral cortex is required for voluntary actions, language, speech and higher functions such as thinking and remembering. Many of these functions are carried out by both sides of the brain, but some are largely lateralised to one cerebral hemisphere or the other. Areas concerned with some of these higher functions, such as speech (which is lateralised in the left hemisphere in most people), have been identified. However there is much still to be learned, particularly about such fascinating issues as consciousness, and so the study of the functions of the cerebral cortex is one of the most exciting and active areas of research in Neuroscience.

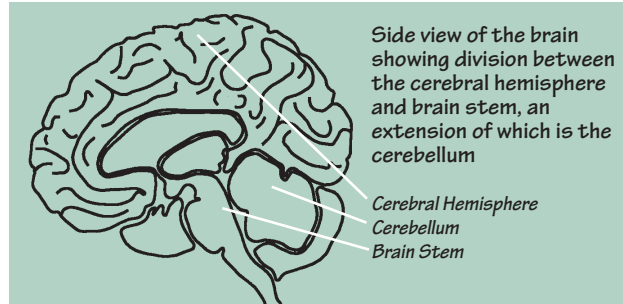

Side view of the brain showing division between the cerebral hemisphere and brain stem, an extension of which is the cerebellum

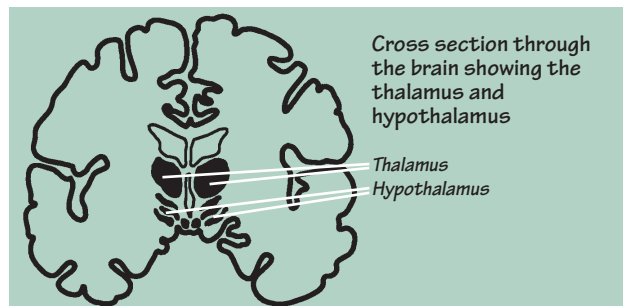

Cross section through the brain showing the thalamus and hypothalamus

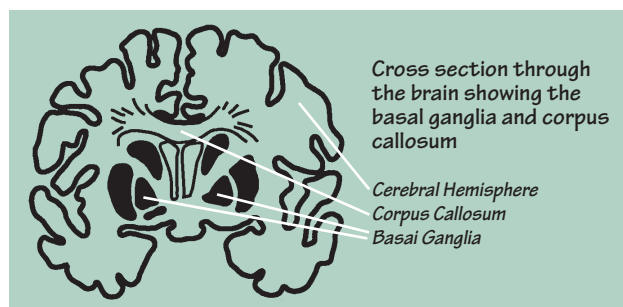

Cross section through the brain showing the basal ganglia and corpus callosum

The father of modern neuroscience, Ramon y Cajal, at his microscope in 1890.



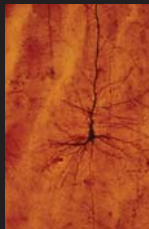

Cajal's first pictures of neurons and their dendrites.

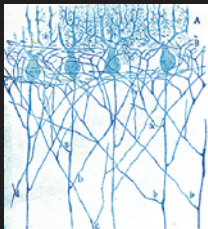

Cajal's exquisite neuron drawings - these are of the cerebellum.



Neurons and the Action Potential

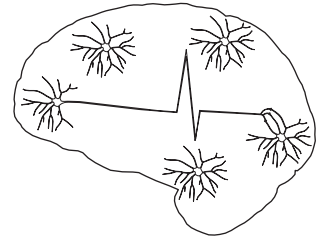

Whether neurons are sensory or motor, big or small, they all have in common that their activity is both electrical and chemical. Neurons both cooperate and compete with each other in regulating the overall state of the nervous system, rather in the same way that individuals in a society cooperate and compete in decision-making processes. Chemical signals received in the dendrites from the axons that contact them are transformed into electrical signals, which add to or subtract from electrical signals from all the other synapses, thus making a decision about whether to pass on the signal elsewhere. Electrical potentials then travel down axons to synapses on the dendrites of the next neuron and the process repeats.

The dynamic neuron

As we described in the last chapter, a neuron consists of **dendrites**, a **cell body**, an **axon** and **synaptic terminals**. This structure reflects its functional subdivision into receiving, integrating and transmitting compartments. Roughly speaking, the dendrite receives, the cell-body integrates and the axons transmit - a concept called **polarization** because the information they process supposedly goes in only one direction.

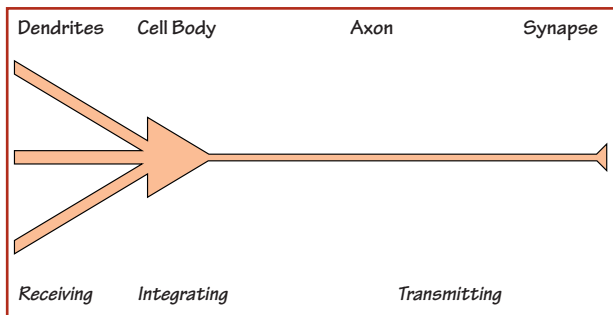

The key concepts of a neuron

Like any structure, it has to hold together. The outer **membranes** of neurons, made of fatty substances, are draped around a **cytoskeleton** that is built up of rods of tubular and filamentous proteins that extend out into dendrites and axons alike. The structure is a bit like a canvas stretched over the tubular skeleton of a frame tent. The different parts of a neuron are in constant motion, a process of rearrangement that reflects its own activity and that of its neighbours. The dendrites change shape, sprouting new connections and withdrawing others, and the axons grow new endings as the neuron struggles to talk a bit more loudly, or a bit more softly, to others.

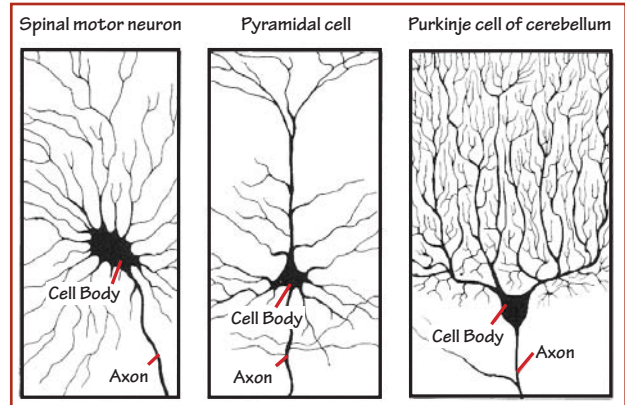

3 different types of Neurons

Inside neurons are many inner **compartments**. These consist of proteins, mostly manufactured in the cell body, that are transported along the cytoskeleton. Tiny protuberances that stick out from the dendrites called **dendritic spines**. These are where incoming axons make most of their connections. Proteins transported to the spines are important for creating and maintaining neuronal connectivity. These proteins are constantly turning over, being replaced by new ones when they've done their job. All this activity needs fuel and there are energy factories (mitochondria) inside the cell that keep it all working. The end-points of the axons also respond to molecules called **growth factors**. These factors are taken up inside and then transported to the cell body where they influence the expression of neuronal genes and hence the manufacture of new proteins. These enable the neuron to grow longer dendrites or make yet other dynamic changes to its shape or function. Information, nutrients and messengers flow to and from the cell body all the time.

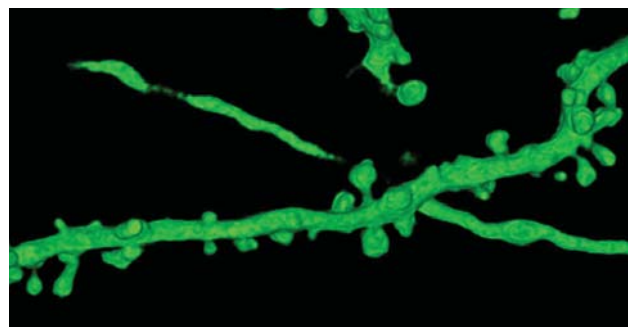

Dendritic spines are the tiny green protuberances sticking out from the green dendrites of a neuron. This is where synapses are located.

Receiving and deciding

On the receiving side of the cell, the dendrites have close contacts with incoming axons of other cells, each of which is separated by a miniscule gap of about 20 billionths of metre. A dendrite may receive contacts from one, a few, or even thousands of other neurons. These junctional spots are named **synapses**, from classical Greek words that mean "to clasp together". Most of the synapses on cells in the

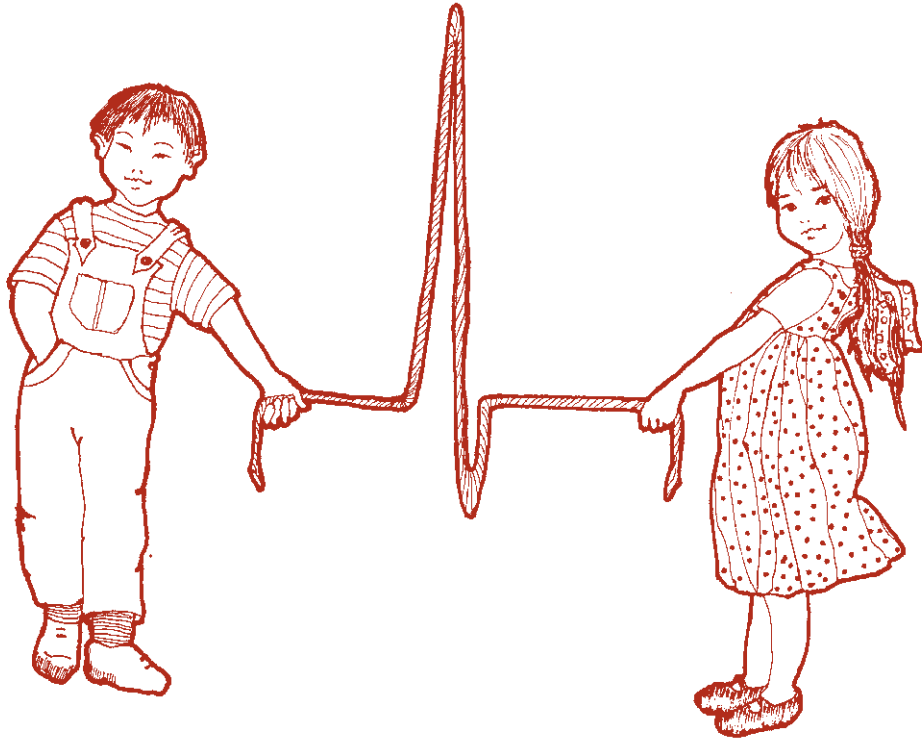

cerebral cortex are located on the dendritic spines that stick out like little microphones searching for faint signals. Communication between nerve cells at these contact points is referred to as **synaptic transmission** and it involves a chemical process that we will describe in the next Chapter. When the dendrite receives one of the chemical messengers that has been fired across the gap separating it from the sending axon, miniature electrical currents are set up inside the receiving dendritic spine. These are usually currents that come into the cell, called **excitation**, or they may be currents that move out of the cell, called **inhibition**. All these positive and negative waves of current are accumulated in the dendrites and they spread down to the cell body. If they don't add up to very much activity, the currents soon die down and nothing further happens. However, if the currents add up to a value that crosses a threshold, the neuron will send a message on to other neurons.

So a neuron is kind of miniature calculator - constantly adding and subtracting. What it adds and subtracts are the messages it receives from other neurons. Some synapses produce excitation, others inhibition. How these signals constitute the basis of sensation, thought and movement depends very much on the network in which the neurons are embedded.

The action-potential

To communicate from one neuron to another, the neuronal signal has first to travel along the axon. How do neurons do this?

The answer hinges on harnessing energy locked in physical and chemical gradients, and coupling together these forces in an efficient way. The axons of neurons transmit electrical

pulses called **action potentials**. These travel along nerve fibres rather like a wave travelling down a skipping rope. This works because the axonal membrane contains **ion-channels**, that can open and close to let through electrically charged ions. Some channels let through sodium ions (Na^+), while others let through potassium ions (K^+). When channels open, the Na^+ or K^+ ions flow down opposing chemical and electrical gradients, in and out of the cell, in response to **electrical depolarisation** of the membrane.

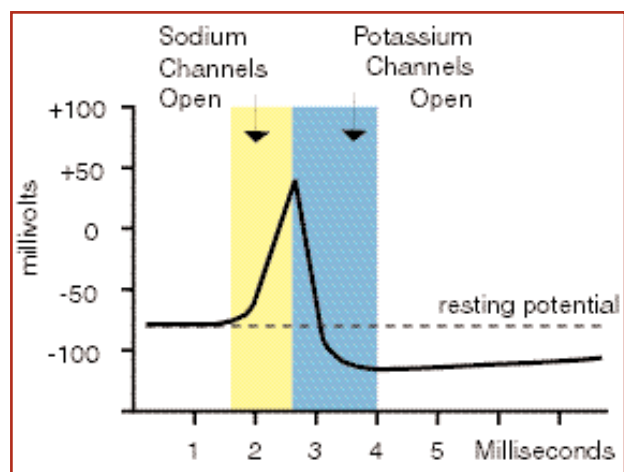

The action potential

When an action potential starts at the cell body, the first channels to open are Na^+ channels. A pulse of sodium ions flashes into the cell and a new equilibrium is established within a millisecond. In a trice, the transmembrane voltage switches by about 100 mV. It flips from an inside membrane voltage that is negative (about -70 mV) to one that is positive (about +30 mV). This switch opens K^+ channels, triggering a pulse of potassium ions to flow out of the cell, almost as rapidly as the Na^+ ions that flowed inwards, and this in turn causes the membrane potential to swing back again to its original negative value on the inside. The action-potential is over within less time than it takes to flick a domestic light switch on and immediately off again. Remarkably few ions traverse the cell membrane to do this, and the concentrations of Na^+ and K^+ ions within the cytoplasm do not change significantly during an action potential. However, in the long run, these ions are kept in balance by **ion pumps** whose job is to bale out excess sodium ions. This happens in much the same way that a small leak in the hull of a sailing boat can be coped with by baling out water with a bucket, without impairing the overall ability of the hull to withstand the pressure of the water upon which the boat floats.

The action potential is an electrical event, albeit a complex one. Nerve fibres behave like electrical conductors (although they are much less efficient than insulated wires), and so an action potential generated at one point creates another gradient of voltage between the active and resting membranes adjacent to it. In this way, the action potential is actively propelled in a wave of depolarisation that spreads from one end of the nerve fibre to the other.

An analogy that might help you think about the conduction of action potentials is the movement of energy along a firework sparkler after it is lit at one end. The first ignition triggers very rapid local sparks of activity (equivalent to the ions flowing in and out of the axon at the location of the action potential), but the overall progression of the sparking wave spreads much more slowly. The marvellous feature of nerve fibres is that after a very brief period of silence (**the refractory period**) the spent membrane recovers its explosive capability, readying the axon membrane for the next action potential.

Much of this has been known for 50 years based on wonderful experiments conducted using the very large neurons and their axons that exist in certain sea-creatures. The large size of these axons enabled scientists to place tiny electrodes inside to measure the changing electrical voltages. Nowadays, a modern electrical recording technique called **patch-clamping** is enabling neuroscientists to study the movement of ions through individual ion-channels in all sorts of neurons, and so make very accurate measurements of these currents in brains much more like our own.

Insulating the axons

In many axons, action-potentials move along reasonably well, but not very fast. In others, action potentials really do skip along the nerve. This happens because long stretches of the axon are wrapped around with a fatty, insulating blanket, made out of the stretched out glial cell membranes, called a **myelin sheath**.

Research Frontiers

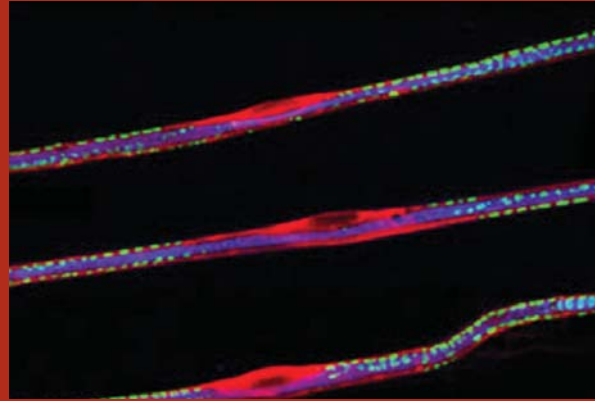

The nerve fibres above (the purple shows the axons) are wrapped in Schwann cells (red) that insulate the electrical transmission of the nerve from its surroundings. The colours are fluorescing chemicals showing a newly discovered protein complex. Disruption of this protein complex causes an inherited disease that leads to muscle-wasting.

New research is telling us about the proteins that make up this myelin sheath. This blanket prevents the ionic currents from leaking out in the wrong place but, every so often the glial cells helpfully leave a little gap. Here the axon concentrates its Na^+ and K^+ ion channels. These clusters of ion channels function as amplifiers that boost and maintain the action potential as it literally skips along the nerve. This can be very fast. In fact, in myelinated neurons, action-potentials can race along at 100 metres per second!

Action potentials have the distinctive characteristic of being **all-or-nothing**; they don't vary in size, only in how often they occur. Thus, the only way that the strength or duration of a stimulus can be encoded in a single cell is by variation of the frequency of action potentials. The most efficient axons can conduct action potentials at frequencies up to 1000 times per second.

Alan Hodgkin and Andrew Huxley won the Nobel Prize for discovering the mechanism of transmission of the nerve impulse. They used the "giant axon" of the squid in studies at the Plymouth Marine Biology Laboratory

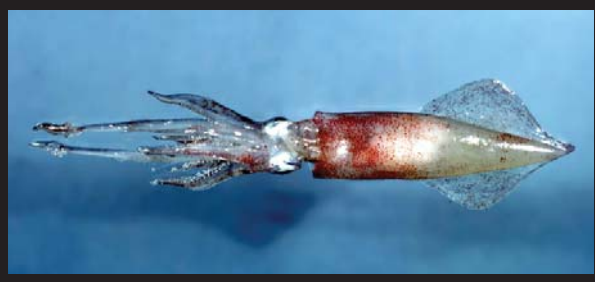
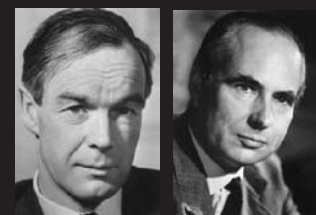

Chemical Messengers

Action potentials are transmitted along axons to specialised regions called **synapses**, where the axons contact the dendrites of other neurons. These consist of a presynaptic nerve ending, separated by a small gap from the postsynaptic component which is often located on a dendritic spine. The electrical currents responsible for the propagation of the action potential along axons cannot bridge the synaptic gap. Transmission across this gap is accomplished by chemical messengers called **neurotransmitters**.

Chemical transmitter packed in spherical bags is available for release across synaptic junctions

Storage and Release

Neurotransmitters are stored in tiny spherical bags called **synaptic vesicles** in the endings of axons. There are vesicles for storage and vesicles closer to nerve endings that are ready to be released. The arrival of an action potential leads to the opening of ion-channels that let in **calcium** (Ca^{++}). This activates enzymes that act on a range of presynaptic proteins given exotic names like "snare", "tagmin" and "brevin" - really good names for the characters of a recent scientific adventure story. Neuroscientists have only just discovered that these presynaptic proteins race around tagging and trapping others, causing the releasable synaptic vesicles to fuse with the membrane, burst open, and release the chemical messenger out of the nerve ending.

This messenger then diffuses across the 20 nanometre gap called the **synaptic cleft**. Synaptic vesicles reform when their membranes are swallowed back up into the nerve ending where they become refilled with neurotransmitter, for subsequent regurgitation in a continuous recycling process. Once it gets to the other side, which happens amazingly quickly - in less than a millisecond - it interacts with specialised molecular structures, called **receptors**, in the membrane of the next neuron. Glial cells are also lurking all

around the synaptic cleft. Some of these have miniature vacuum cleaners at the ready, called **transporters**, whose job is to suck up the transmitter in the cleft. This clears the chemical messengers out of the way before the next action potential comes. But nothing is wasted - these glial cells then process the transmitter and send it back to be stored in the storage vesicles of the nerve endings for future use. Glial-cell housekeeping is not the only means by which neurotransmitters are cleared from the synapse. Sometimes the nerve cells pump the transmitter molecules back directly into their nerve endings. In other cases, the transmitter is broken down by other chemicals in the synaptic cleft.

Messengers that open ion channels

The interaction of neurotransmitters with receptors resembles that of a **lock and key**. The attachment of the transmitter (the key) to the receptors (the lock) generally causes the opening of an ion channel; these receptors are called **ionotropic receptors** (see Figure). If the ion channel allows positive ions (Na^+ or Ca^{++}) to enter, the inflow of positive current leads to excitation. This produces a swing in the membrane potential called an excitatory post-synaptic potential (epsp). Typically, a large number of synapses converge on a neuron and, at any one moment, some are active and some are not. If the sum of these epsps reaches the threshold for firing an impulse, a new action potential is set up and signals are passed down the axon of the receiving neuron, as explained in the previous chapter.

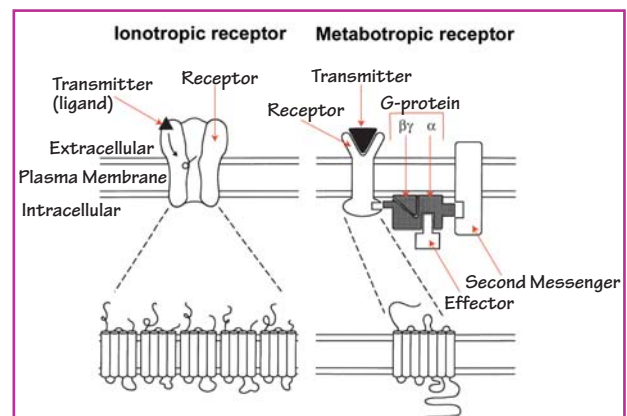

Ionotropic receptors (left) have a channel through which ions pass (such as Na^+ and K^+). The channel is made up of five sub-units arranged in a circle. **Metabotropic receptors** (right) do not have channels, but are coupled to G-proteins inside the cell-membrane that can pass on the message.

The main excitatory neurotransmitter in the brain is **glutamate**. The great precision of nervous activity requires that excitation of some neurons is accompanied by suppression of activity in other neurons. This is brought about by **inhibition**. At **inhibitory synapses**, activation of receptors leads to the opening of ion channels that allow the inflow of negatively charged ions giving rise to a change in membrane potential called an inhibitory post-synaptic potential (ipsp) (see Figure). This opposes membrane depolarisation and therefore the initiation of an action potential at the cell body of the receiving neuron. There are two inhibitory neurotransmitters – **GABA and glycine**.

Synaptic transmission is a very rapid process: the time taken from the arrival of an action potential at a synapse to the generation of an epsp in the next neuron is very rapid - 1/1000 of a second. Different neurons have to time their delivery of glutamate on to others within a short window of opportunity if the epsps in the receiving neuron are going to add up to trigger a new impulse; and inhibition also has to operate within the same interval to be effective in shutting things down.

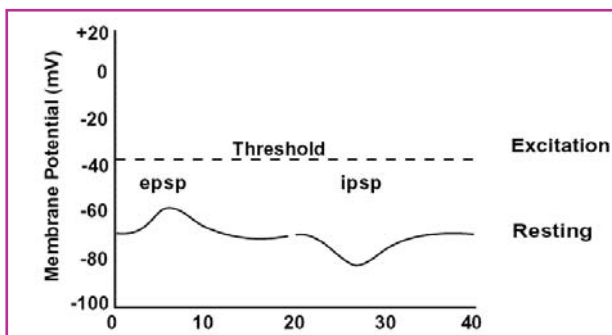

The excitatory synaptic potential (epsp) is a shift in membrane potential from -70 mV to a value closer to 0 mV. An inhibitory synaptic potential (ipsp) has the opposite effect.

Messengers that modulate

The hunt for the identity of the excitatory and inhibitory neurotransmitters also revealed the existence of a large number of other chemical agents released from neurons. Many of these affect neuronal mechanisms by interacting with a very different set of proteins in the membranes of neurons called **metabotropic receptors**. These receptors don't contain ion channels, are not always localised in the region of the synapse and, most importantly, do not lead to the initiation of action potentials. We now think of these receptors as adjusting or modulating the vast array of chemical processes going on inside neurons, and thus the action of metabotropic receptors is called **neuromodulation**.

Metabotropic receptors are usually found in complex particles linking the outside of the cell to enzymes inside the cell that affect cell metabolism. When a neurotransmitter is recognised and bound by a metabotropic receptor, bridging molecules called **G-proteins**, and other membrane-bound enzymes are collectively triggered. Binding of the transmitter to a metabotropic recognition site can be compared to an ignition key. It doesn't open a door for

ions in the membrane, as ionotropic receptors do, but instead kick-starts intracellular second messengers into action, engaging a sequence of biochemical events (see Figure). The metabolic engine of the neuron then revs up and gets going. The effects of neuromodulation include changes in ion channels, receptors, transporters and even the expression of genes. These changes are slower in onset and more long-lasting than those triggered by the excitatory and inhibitory transmitters and their effects extend well beyond the synapse. Although they do not initiate action potentials, they have profound effects on the impulse traffic through neural networks.

Identifying the messengers

Among the many messengers acting on G-protein coupled receptors are **acetylcholine, dopamine** and **noradrenaline**. Neurons that release these transmitters not only have a diverse effect on cells, but their anatomical organisation is also remarkable because they are relatively few in number but their axons project widely through the brain (see Figure). There are only 1600 noradrenaline neurons in the human brain, but they send axons to all parts of the brain and spinal cord. These neuromodulatory transmitters do not send out precise sensory information, but fine-tune dispersed neuronal assemblies to optimise their performance.

Noradrenaline is released in response to various forms of novelty and stress and helps to organise the complex response of the individual to these challenges. Lots of networks may need to "know" that the organism is under stress. Dopamine makes certain situations rewarding for the animal, by acting on brain centres associated with positive emotional features (see Chapter 4). Acetylcholine, by contrast, likes to have it both ways. It acts on both ionotropic and metabotropic receptors. The first neurotransmitter to be discovered, it uses ionic mechanisms to signal across the neuromuscular junction from motor neurons to striated muscle fibres. It can also function as a neuromodulator. It does this, for example, when you want to focus attention on something - fine-tuning neurons in the brain to the task of taking in only relevant information.

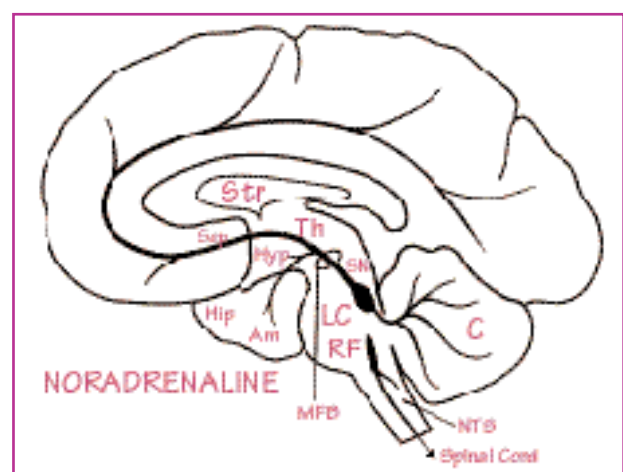

Noradrenaline cells are located in the locus coeruleus (LC). Axons from these cells are distributed throughout the midbrain such as the hypothalamus (Hyp), the cerebellum (C) and cerebral cortex.



Drugs and the Brain

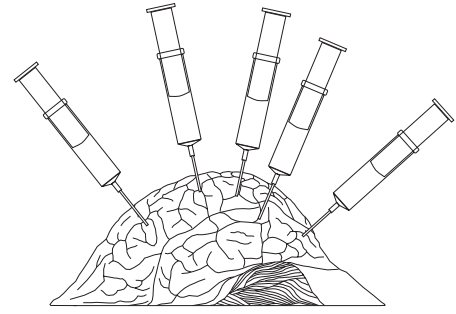

Many people seem to have a constant desire to alter their state of consciousness using drugs. They use stimulant drugs to help them stay awake and dance the night away. Others use sedatives to calm their nerves. Or even substances that enable them to experience new forms of consciousness and to forget the troubles of everyday life. All of these drugs interact in different ways with neurotransmitter and other chemical messenger systems in the brain. In many cases, the drugs hijack natural brain systems that have to do with pleasure and reward - psychological processes that are important in eating, drinking, sex and even learning and memory.

The Path to Addiction and Dependence

Drugs that act on the brain or the blood supply of the brain can be invaluable - such as those that relieve pain. Recreational drug use has a very different purpose, and the problem with it is that it can lead to abuse. The user can, all too easily, become **dependent** or even **addicted**. He or she will then suffer very unpleasant physical and psychological withdrawal symptoms when they interrupt their drug habit. This state of dependence can lead a user to crave the drug, even though doing so is clearly damaging to their work, health and family. In extreme cases the user may be drawn into crime in order to pay for the drug.

Fortunately not everyone who takes a recreational drug becomes dependent on it. Drugs differ in their dependence liability - ranging from high risk in the case of **cocaine, heroin** and **nicotine** to lower risk in the case of **alcohol, cannabis, ecstasy** and **amphetamines**. During the development of drug

dependence the body and brain slowly adapt to the repeated presence of the drug, but exactly what changes go on in the brain remain mysteries. Although the primary sites of action of heroin, amphetamines, nicotine, cocaine and cannabis are all different, these drugs share an ability to promote the release of the chemical messenger **dopamine** in certain brain regions. Although this is not necessarily akin to triggering a "pleasure" mechanism, it is thought that the drug-induced release of dopamine may be an important final common pathway of "pleasure" in the brain. It represents the signal that prompts a person to carry on taking the drug.

Individual Drugs - How they work and the hazards of taking them.

Alcohol

Alcohol acts on neurotransmitter systems in the brain to dampen down excitatory messages and promote inhibition of neural activity. Alcohol's action proceeds through stages of relaxation and good humour, after one drink, through to sleepiness and loss of consciousness. That is why the police are so strict about drinking and driving, and why there is so much public support for this strict attitude. Some people become very aggressive and even violent when they drink, and about one in ten of regular drinkers will become dependent alcoholics. Long-term alcohol use damages the body, especially the liver, and can cause permanent damage to the brain. Pregnant mothers who drink run the risk of having babies with damaged brains and low IQ's. More than 30,000 people die every year in Britain from alcohol-related diseases.

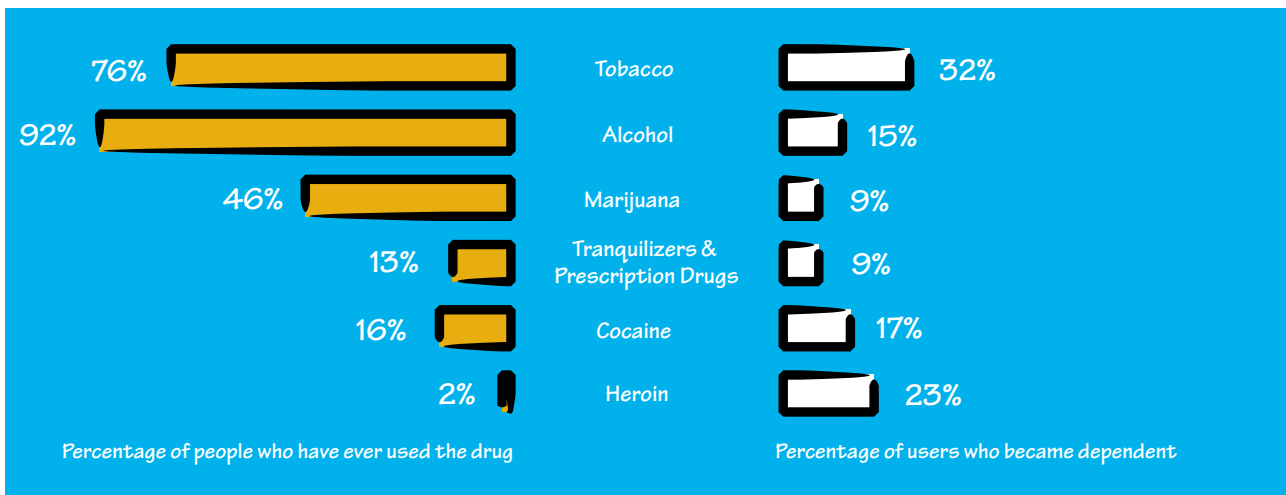



"Skull with a burning cigarette" by Vincent Van Gogh 1885.

Nicotine

Nicotine is the active ingredient in all tobacco products. Nicotine acts on brain receptors that normally recognise the neurotransmitter acetylcholine; it tends to activate natural alerting mechanisms in the brain. Given this, it's not surprising that smokers say that cigarettes help them concentrate and have a soothing effect. The trouble is that nicotine is highly addictive and many inveterate smokers continue to smoke for no better reason than to avoid the unpleasant signs of withdrawal if they stop. The pleasure has long gone. While there appears to be no deleterious effect on the brain, tobacco smoke is extremely damaging to the lungs and long-term exposure can lead to lung cancer and also to other lung and heart diseases. More than 100,000 people die every year in Britain from smoking-related diseases.

Cannabis

Cannabis presents us with a puzzle, for it acts on an important natural system in the brain that uses neurotransmitters that are chemically very like cannabis. This system has to do with the control of muscles and regulating pain sensitivity. Used wisely, and in a medical context, cannabis can be a very useful drug. Cannabis is an intoxicant which can be pleasurable and relaxing, and it can cause a dream-like state in which one's perception of sounds, colours and time is subtly altered. No-one seems to have died from an overdose, although some users may experience unpleasant panic attacks after large doses. Cannabis has been used at least once by nearly half the population of Britain under the age of 30. Some people believe it should be legalised - and doing so could cut the link between supply of the drug and that of other much more dangerous drugs. Unfortunately, as with nicotine, smoking is the most effective way of delivering it to the body. Cannabis smoke contains much the same mixture of poisons as cigarettes (and is often smoked with tobacco).

Cannabis smokers tend to develop lung diseases and they run the risk of developing lung cancer - although this has not yet been proved. About one in ten users may become dependent, which people who sell the drug are well aware of. Repeated heavy use is incompatible with the skill of driving and with intellectually demanding work; experiments have established that people intoxicated with cannabis are unable to carry out complex mental tasks. Although not yet proven, there is some evidence that heavy use by young people might trigger the mental illness schizophrenia (see p.51) in susceptible individuals.

Amphetamines

Amphetamines are man-made chemicals that include "Dexedrine", "Speed", and the methamphetamine derivative called "Ecstasy". These drugs act in the brain by causing the release two naturally occurring neurotransmitters. One is dopamine - which probably explains the strong arousal and pleasurable effects of amphetamines. The other is serotonin - which is thought to account for their ability to cause a sense of well-being and a dream-like state that can include hallucinations. Dexedrine and Speed promote mainly dopamine release, Ecstasy more serotonin. The even more powerful hallucinogen d-LSD also acts on serotonin mechanisms in the brain. Amphetamines are powerful psychostimulants and they can be dangerous - especially in overdose. Animal experiments have shown that Ecstasy can cause a prolonged, perhaps permanent reduction of serotonin cells. This might account for the "mid-week blues" suffered by weekend ecstasy users. Every year, dozens of young people die after taking it. Frightening schizophrenia-like psychosis can happen after Dexedrine and Speed. You might be lured into thinking that Speed could help you in an exam - but don't. It won't.

Heroin

Heroin is a man-made chemical derivative of the plant product morphine. Like cannabis, heroin hijacks a system in the brain that employs naturally occurring neurotransmitters known as endorphins. These are important in pain control - and so drugs that copy their actions are very valuable in medicine. Heroin is injected or smoked whereupon it causes an immediate pleasurable sensation - possibly due to an effect of endorphins on reward mechanisms. It is highly addictive, but, as dependence develops, these pleasurable sensations quickly subside to be replaced by an incessant "craving". It is a very dangerous drug that can kill in even modest overdose (it suppresses breathing reflexes). Heroin has ruined many people's lives.

Cocaine

Cocaine is another plant-derived chemical which can cause intensely pleasurable sensations as well as acting as a powerful psychostimulant. Like the amphetamines, cocaine makes more dopamine and serotonin available in the brain. However, like heroin, cocaine is a very dangerous drug. People intoxicated with it, especially the smoked form called "crack", can readily become violent and aggressive, and there is a life-threatening risk of overdose. The dependence liability is high, and the costs of maintaining a cocaine habit draw many users into crime.



Touch & Pain

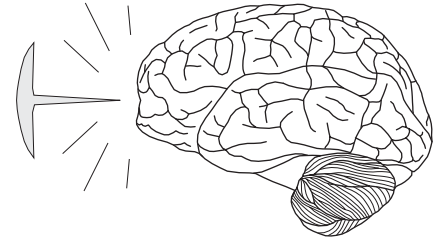

Touch is special - a handshake, a kiss, a baptism. It provides our first contact with the world. Arrays of receptors throughout our bodies are tuned to different aspects of the somatosensory world - touch, temperature and body position - with yet others for the sensations of pain. The power of discrimination varies across the body surface, being exquisitely sensitive at places such as the tips of our fingers. Active exploration is important as well, pointing to important interactions with the motor system. Pain serves to inform and to warn us of damage to our bodies. It has a strong emotional impact, and is subject to powerful controls within the body and brain.

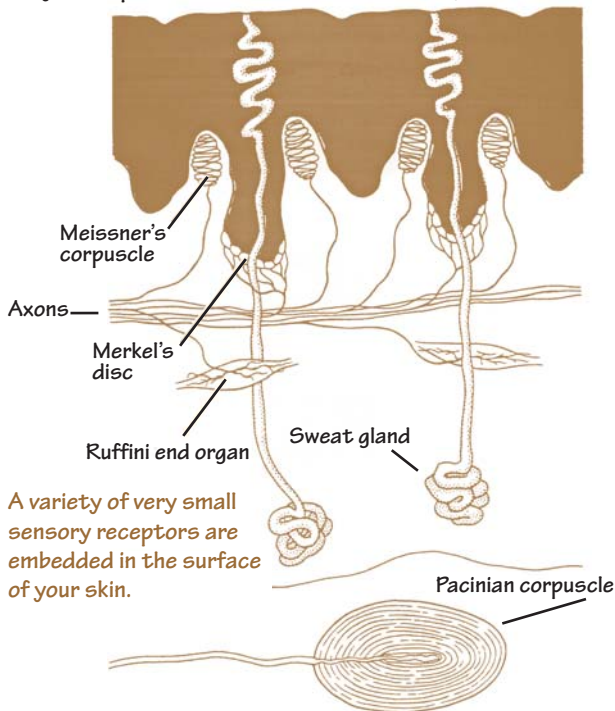

It begins in the skin

Embedded in the dermal layers of the skin, beneath the surface, are several types of tiny receptors. Named after the scientists who first identified them in the microscope, **Pacianian** and **Meissner** corpuscles, **Merkel's** disks and **Ruffini** endings sense different aspects of touch. All these receptors have ion channels that open in response to mechanical deformation, triggering action potentials that can be recorded experimentally by fine electrodes. Some amazing experiments were conducted some years ago by scientists who experimented on themselves, by inserting electrodes into their own skin to record from single sensory nerves. From these and similar experiments in anaesthetised animals, we now know that the first two types of receptor

adapt quickly and so respond best to rapidly changing indentations (sense of **vibration** and **flutter**), Merkel's disk responds well to a sustained indentation of the skin (sense of **pressure**), while Ruffini endings respond to slowly changing indentations.

An important concept about somatosensory receptors is that of the **receptive field**. This is the area of skin over which each individual receptor responds. Pacinian corpuscles have much larger receptive fields than Meissner's corpuscles. Together, these and the other receptors ensure that you can feel things over your entire body surface. Once they detect a stimulus, the receptors in turn send impulses along the sensory nerves that enter the dorsal roots of the spinal cord. The axons connecting touch receptors to the spinal cord are large myelinated fibres that convey information from the periphery towards the cerebral cortex extremely rapidly. Cold, warmth and pain are detected by thin axons with "naked" endings, which transmit more slowly. Temperature receptors also show **adaptation** (see Experiment Box). There are relay stations for touch in the medulla and the thalamus, before projection on to the primary sensory area in the cortex called the **somatosensory cortex**. The nerves cross the midline so that the right side of the body is represented in the left hemisphere and the left in the right.



An Experiment on Temperature Adaptation

This experiment is very simple. You need a metal rod about a metre long, such as a towel rail, and two buckets of water. One bucket should contain fairly hot water, the other with water as cold as possible. Put your left hand in one bucket and your right hand in the other, and keep them there for at least a minute. Now take your hands out, dry them very quickly and hold the metal rod. The two ends of the rod will feel as though they are at different temperatures. Why?

The input from the body is systematically "mapped" across the somatosensory cortex to form a **representation of the body surface**. Some parts of the body, such as the tips of your fingers and mouth, have a high density of receptors and a correspondingly higher number of sensory nerves. Areas such as our back have far fewer receptors and nerves. However, in the somatosensory cortex, the packing density

of neurons is uniform. Consequently, the 'map' of the body surface in the cortex is very distorted. Sometimes called the sensory **homunculus**, this would be a curiously distorted person if it actually existed with its complement of touch receptors spread at a uniform density across the body surface.

You can test this differential sensitivity across the body with the **two-point discrimination test**. Bend some paper clips into a U-shape, some with the tips 2-3 cm apart, others much closer. Then, with a blindfold on, get a friend to touch various parts of your body with the tips of the paper clips. Do you feel one tip or two? Do you sometimes feel one tip when you are actually being touched by two? Why?

The homunculus. The image of a person is drawn across the surface of the somatosensory cortex in proportion to the number of receptors coming from that part of the body. They have a most distorted shape.

The exquisite power of discrimination

The ability to perceive fine detail varies greatly across different parts of the body and is most highly developed in the tips of the fingers and lips. Skin is sensitive enough to measure a raised dot that is less than 1/100th of a millimetre high – provided you stroke it as in a blind person reading Braille. One active area of research asks how the different types of receptor contribute to different tasks such as discriminating between textures or identifying the shape of an object.

Touch is not just a passive sense that responds only to what it receives. It is also involved in the **active control of movement**. Neurons in the motor cortex controlling the muscles in your arm that move your fingers get sensory input from touch receptors in the finger tips. How better to detect an object that is starting to slip out of your hand than via rapid communication between the sensory and motor systems? Cross-talk between sensory and motor systems begins at the first relays in the spinal cord,

including proprioceptive feedback on to motor neurons, and it continues at all levels of the somatosensory system.

The primary sensory and motor cortices are right beside each other in the brain.

Active exploration is crucial for the sense of touch. Imagine that you are discriminating fine differences in texture, such as between different fabrics or grades of sandpaper. Which of the following conditions do you think generates the finest discriminations:

- **Placing your finger-tips on the samples?**
- **Running your finger-tips over the samples?**
- **Having a machine run the samples over your finger-tips?**

The outcome of such behavioural experiments leads to questions about where in the brain the relevant sensory information is analysed. Functional brain imaging suggests that the identification of textures or of objects by touch involves different regions of cortex. Brain imaging is also starting to produce insights about **cortical plasticity** by revealing that the map of the body in the somatosensory area can vary with experience. For example, blind Braille readers have an increased cortical representation for the index finger used in reading, and string players an enlarged cortical representation of the fingers of the left hand.

Pain

Although often classed with touch as another skin sense, pain is actually a system with very different functions and a very different anatomical organisation. Its main attributes are that it is unpleasant, that it varies greatly between individuals and, surprisingly, that the information conveyed by pain receptors provides little information about the nature of the stimulus (there is little difference between the pain due an abrasion and a nettle sting). The ancient Greeks regarded pain as an emotion not a sensation.

Recording from single sensory fibres in animals reveals responses to stimuli that cause or merely threaten tissue damage - intense mechanical stimuli (such as pinch), intense heat, and a variety of chemical stimuli. But such experiments tell us nothing directly about subjective experience.

Molecular biological techniques have now revealed the structure and characteristics of a number of **nociceptors**. They include receptors that respond to heat above 46°C, to tissue acidity and - again a surprise - to the active ingredient of chilli peppers. The genes for receptors responding to intense mechanical stimulation have not yet been identified, but they must be there. Two classes of peripheral afferent fibres respond to noxious stimuli: relatively fast myelinated fibres, called **Aδ fibres**, and very fine, slow, non-myelinated **C fibres**. Both sets of nerves enter the spinal cord, where they synapse with a series of neurons that project up to the cerebral cortex. They do so through parallel ascending pathways, one dealing with the localisation of pain (similar to the pathway for touch), the other responsible for the emotional aspect of pain.

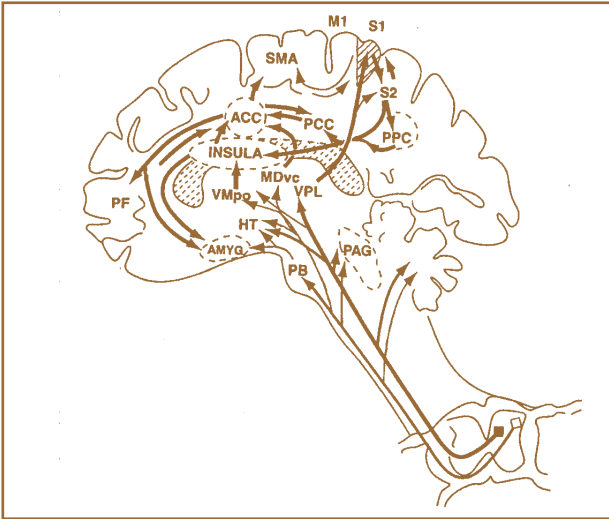

Ascending pathways for pain from a region of the spinal cord (bottom) up to several areas in the brainstem and cortex including ACC (anterior cingulate) and the insular.

This second pathway projects to quite different areas than the somatosensory cortex, including **the anterior cingulate cortex** and the **insular cortex**. In brain-imaging experiments using hypnosis, it has been possible to separate mere pain sensation from the 'unpleasantness' of pain.

Subjects immersed their hands in painfully hot water and were then subjected to hypnotic suggestion of increased or decreased pain intensity or pain unpleasantness. Using positron emission tomography (PET), it was found that during changes in experienced pain intensity there was activation of the somatosensory cortex, whereas the experience of pain unpleasantness was accompanied by activation of the anterior cingulate cortex.

A life without pain?

Given our desire to avoid sources of pain, such as the dentist, you might imagine that a life without pain would be good. Not so. For one of the key functions of pain is to enable us to learn to avoid situations that give rise to pain. Action potentials in the nociceptive nerves entering the spinal cord initiate automatic protective reflexes, such as the withdrawal reflex. They also provide the very information that guides learning to avoid dangerous or threatening situations.

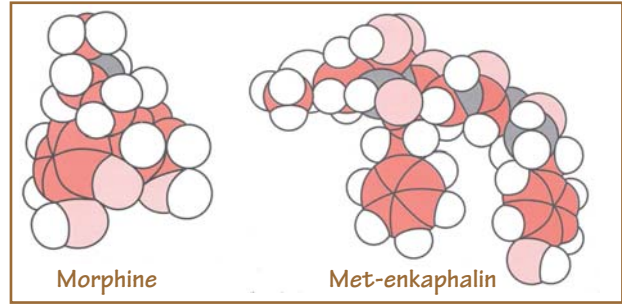

Another key function of pain is the inhibition of activity - the rest that allows healing to occur after tissue damage. Of course, in some situations, it is important that activity and escape reactions are not inhibited. To help cope in these situations, physiological mechanisms have evolved that can either suppress or enhance pain. The first such modulatory mechanism to be discovered was the release of **endogenous analgesics**. Under conditions of likely injury, such as soldiers in battle, pain sensation is suppressed to a surprising degree - presumably because these substances are released. Animal experiments have revealed that electrical stimulation of brain areas such as the aqueductal gray matter causes a marked elevation in the pain threshold and that this is mediated by a descending pathway from the midbrain to the spinal cord.



A number of chemical transmitters are involved including endogenous opioids such as **met-enkephalin**. The pain-killer **morphine** acts on the same receptors at which some of the endogenous opioids act.

The converse phenomenon of enhanced pain is called **hyperalgesia**. There is a lowering of the pain threshold, an increase in the intensity of pain, and sometimes both a broadening of the area over which pain is felt or even pain in the absence of noxious stimulation. This can be a major clinical problem. Hyperalgesia involves sensitisation of the peripheral receptors as well as complex phenomena at various levels of the ascending pain pathways. These include the interaction of chemically mediated excitation and inhibition. The hyperalgesia observed in chronic pain states results from the enhancement of excitation and depression of inhibition. Much of this is due to changes in the responsiveness of the neurons that process sensory information. Important changes occur in the receptor molecules that mediate the action of the relevant neurotransmitters. In spite of the great advances in our understanding of the cellular mechanisms of hyperalgesia, the clinical treatment of chronic pain is still sadly inadequate.

Research Frontiers

Traditional Chinese Medicine uses a procedure called "acupuncture" for the relief of pain. This involves fine needles, inserted into the skin at particular positions in the body along what are called meridians, which are then rotated or vibrated by the person treating the patient. They certainly relieve pain but, until recently, no one was very sure why.

Forty years ago, a research laboratory was set up in China to find out how it works. Its findings reveal that electrical stimulation at one frequency of vibration triggers the release of endogenous opioids called endorphins, such as met-enkephalin, while stimulation at another frequency activates a system sensitive to dynorphins. This work has led to the development of an inexpensive electrical acupuncture machine (left) that can be used for pain relief instead of drugs. A pair of electrodes are placed at the "Heku" points on the hand (right), another at the site of pain.

Vision

Humans are highly visual animals constantly using their eyes to make decisions about the world. With forward facing eyes like other primates, we use vision to sense those many aspects of the environment that are remote from our bodies. Light is a form of electromagnetic energy that enters our eyes where it acts on photoreceptors in the retina. This triggers processes by which neural impulses are generated and then travel through the pathways and networks of the visual brain. Separate pathways to the midbrain and the cerebral cortex mediate different visual functions - detecting and representing motion, shape, colour and other distinctive features of the visual world. Some but not all are accessible to consciousness. In the cortex, neurons in a large number of distinctive visual areas are specialised for making different kinds of visual decisions.

Light on the eye

Light enters the eye through the pupil and is focused, by the cornea and the lens, on to the retina at the back of the eye. The pupil is surrounded by a pigmented iris that can expand or contract, making the pupil larger or smaller as light levels vary. It is natural to suppose that the eye acts like a camera, forming an 'image' of the world, but this is a misleading metaphor in several respects. First, there is never a static image because the eyes are always moving. Second, even if an image on the retina were to send an image into the

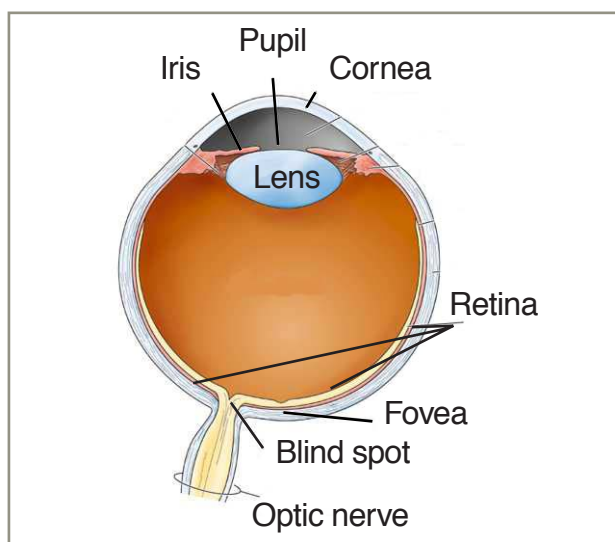

The human eye. Light entering the eye is focused by the lens onto the retina located at the back. Receptors there detect the energy and by a process of transduction initiate action-potentials that travel in the optic nerve.

brain, "seeing" this next image would then need another person to look at it - a person inside the brain! To avoid an infinite regression, with nothing really explained along the way, we confront the really big problem that the visual brain has to solve - how it uses coded messages from the eyes to interpret and make decisions about the visual world.

Once focused on the retina, the 125 million photoreceptors arranged across the surface of the retina respond to the light that hits them by generating tiny electrical potentials. These signals pass, via synapses through a network of cells in the retina, in turn activating retinal ganglion cells whose axons collect together to form the optic nerve. These enter the brain where they transmit action potentials to different visual regions with distinct functions.

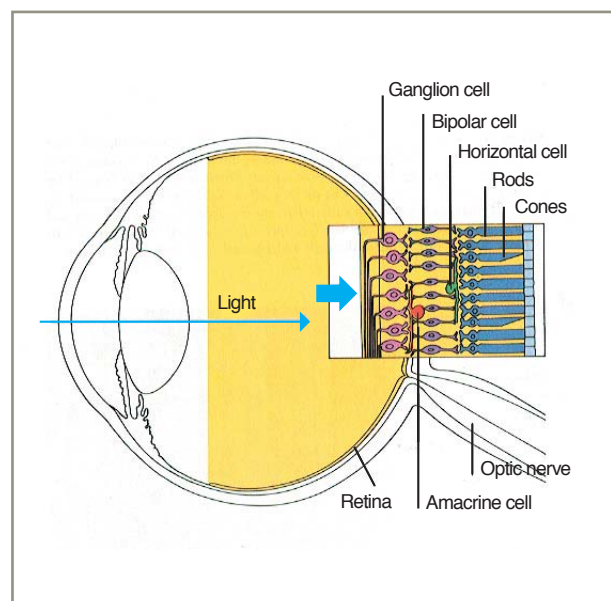

The retina. Light passes through the fibres of the optic nerve and a network of cells (eg. bipolar cells) to land on the rods and cones at the back of the retina.

Much has been learned about this earliest stage of visual processing. The most numerous photoreceptors, called rods, are about 1000 times more sensitive to light than the other, less numerous category called cones. Roughly speaking, you see at night with your rods but by day with your cones. There are three types of cones, sensitive to different wavelengths of light. It is oversimplification to say it is the cones simply produce colour vision - but they are vital for it. If over-exposed to one colour of light, the pigments in the cones adapt and then make a lesser contribution to our perception of colour for a short while thereafter (see Experiment Box).

Over the past 25 years, important discoveries have been made about the process of **phototransduction** (the conversion of light into electrical signals in the rods and cones), the genetic basis of colour blindness which is due to the absence of certain visual pigments, the function of the retinal network and the presence of two different types of ganglion cells. About 90% of these cells are very small, while another 5% are large M-type or **magnocellular** cells. We shall see later that abnormalities in the M-Type cells may underlie certain cases of dyslexia (Chapter 9).



An Experiment on Colour Adaptation

Focus on the small fixation cross (+) between the two large circles for at least 30 sec. Now transfer your gaze to the lower fixation cross. The two "yellow" circles will now appear to be different colours. Can you think out why this might have happened?

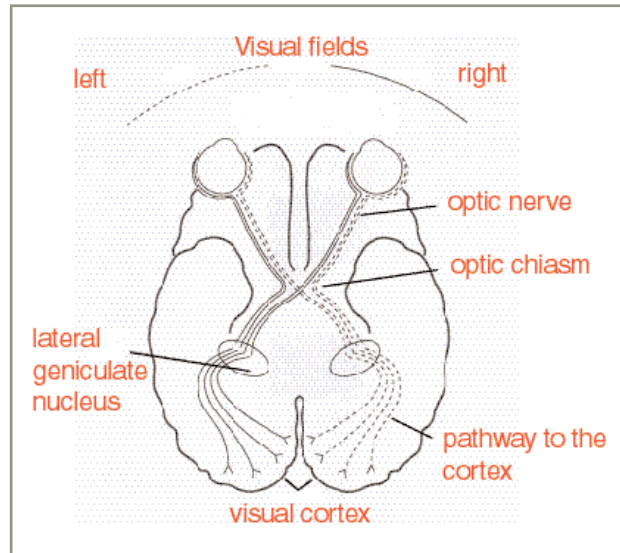

The pathways from eye to brain.

The visual cortex consists of a number of areas, dealing with the various aspects of the visual world such as shape, colour, movement, distance etc. These cells are arranged in columns. An important concept about visually responsive cells is that of the **receptive field** - the region of retina over which the cell will respond to the preferred kind of image. In V1, the first stage of cortical processing, the neurons respond best to lines or edges in a particular orientation. An important discovery was that all the neurons in any one column of cells fire to lines or edges of the same **orientation**, and the neighbouring column of cells fires best to a slightly different orientation, and so on across the surface of V1. This means cortical visual cells have an intrinsic organisation for interpreting the world, but it is not an organisation that is immutable. The extent to which an individual cell can be driven by activity in the left or right eye is modified by experience. As with all sensory systems the visual cortex displays what we call **plasticity**.

The next steps in visual processing

The **optic nerve** of each eye projects to the brain. The fibres of each nerve meet at a structure called the optic chiasm; half of them "cross" to the other side where they join the other half from the other optic nerve that have stayed "uncrossed". Together these bundles of fibres form the **optic tracts**, now containing fibres from both eyes, which now project (via a synaptic relay in a structure called the lateral geniculate nucleus) to the cerebral cortex. It is here that internal "representations" of visual space around us are created. In a similar way to touch (previous Chapter), the left-hand side of the visual world is in the right-hemisphere and the right-hand side in the left-hemisphere. This neural representation has inputs from each eye and so the cells in the visual areas at the back of the brain (called **area V1, V2** etc.) can fire in response to an image in either eye. This is called **binocularity**.

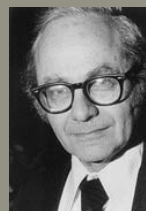

David Hubel



Torsten Wiesel

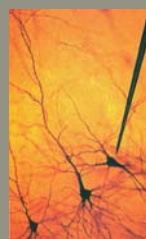

Electrical recordings made from cells in the visual cortex (left) by David Hubel and Torsten Wiesel (above) have revealed some amazing properties. These include orientation selectivity, the beautiful columnar organisation of such cells (below) and the plasticity of the system. These discoveries led to the award of the Nobel Prize.

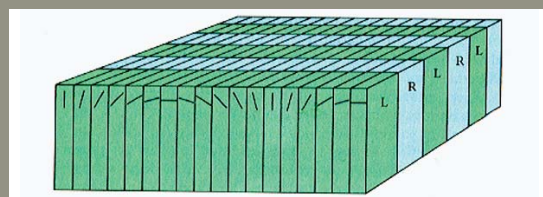

Research Frontiers

Can you see if you are blind? Surely not. However, the discovery of multiple visual areas in the brain has shown that some visual abilities occur without conscious awareness. Certain people who have sustained damage to the primary visual cortex (V1) report being unable to see things in their field of view but, when asked to reach for the things they claim they cannot see, they do so with remarkable accuracy. This curious but fascinating phenomenon is known as "blindsight". This is probably mediated by parallel connections from the eyes to other parts of the cortex.

Being unaware of things one sees is an everyday phenomenon in normal people too. If you chat with a passenger whilst driving your car, your conscious awareness may be directed entirely to the conversation - yet you drive effectively, stopping at lights and avoiding obstacles. This ability reflects a kind of functional blindsight.

The intricate circuitry of the visual cortex is one of the great puzzles that has preoccupied neuroscientists. Different types of neurons are arranged across the six cortical layers, connected together in very precise local circuits that we are only now starting to understand. Some of their connections are excitatory and some inhibitory. Certain neuroscientists have suggested there is a **canonical cortical microcircuit** - like chips in a computer. Not everyone agrees. We now think the circuitry in one visual area has many similarities to that in another, but there could be subtle differences that reflect the different ways in which each bit of the visual brain interprets different aspects of the visual world. Study of visual illusions has also given us insight into the kind of processing that may be going on at different stages of visual analysis.

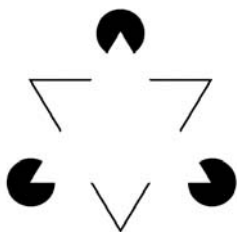

The tiles of this famous café wall in Bristol (left) are actually rectangular - but they don't look it. The tiling arrangement creates an illusion caused by complex excitatory and inhibitory interactions amongst neurons processing lines and edges. The Kanizsa Triangle (right) doesn't really exist - but this doesn't stop you seeing it! Your visual system "decides" that a white triangle is on top of the other objects in the scene.

Decision and Indecision

A key function of the cerebral cortex is its ability to form and act upon sensory information received from many sources. **Decision making** is a critical part of this capability. This is the thinking, knowledge-based, or "cognitive" part of the process. Available sensory evidence must be weighed up and choices made (such as to act or refrain from acting) on the best evidence that can be obtained at that time. Some decisions are complex and require extended thinking while



Just black and white dots? It is at first hard to identify to edges or surfaces of the image. But once you know it is a Dalmatian dog, the image "pops out". The visual brain uses internal knowledge to interpret the sensory scene.

others can be simple and automatic. Even the simplest decisions involve an interplay between sensory input and existing knowledge.

One way to try to understand the neural basis of decision-making would be to let an individual go about their normal daily activity and record the activity of neurons as they do various things. We might imagine being able to record, with millisecond precision, the activity of every single one of the 10^{11} neurons of the brain. We would then have not only a lot of data, but also a formidable task in processing it all. We would have an even greater problem in interpreting it. To understand why, think for a moment about the different reasons why people do things. A person we see walking to a railway station may be going there to catch a train, to meet someone off a train, or even to go "train-spotting". Without knowing what their intentions are, it might prove very difficult to interpret the correlations between any patterns of activation in their brain and their behaviour.

Experimental neuroscientists like, therefore, to bring behavioural situations under **precise experimental control**. This can be achieved by setting a specific task, ensuring that the human subjects are doing it to the best of their ability after extensive practice, and then monitoring their performance. The best kind of task is one that is sufficiently complex to be interesting, yet sufficiently simple to offer a chance of being able to analyse what is going on. A good example is the process of making a visual decision about the appearance of stimuli - often no more than two stimuli - with the response being a simple choice (e.g. which spot of light is bigger, or brighter?). Although such a task is simple, it does incorporate a complete cycle of decision-making. Sensory information is acquired and analysed; there are correct and incorrect answers for the decision made; and rewards can be assigned according to whether performance was correct or not. This sort of research is a kind of "physics of vision".

Decisions about motion and colour

A subject of great current interest is how neurons are involved in making decisions about **visual motion**. Whether or not an object is moving, and in which direction, are critically important judgements for humans and other animals. Relative movement generally indicates that an object is different from other nearby objects. The regions of the visual brain involved in processing motion information can be identified as distinct anatomical regions by examining the patterns of connections between brain areas, by using human brain imaging techniques (Chapter 14), and by recording the activity of individual neurons in non-human animals.

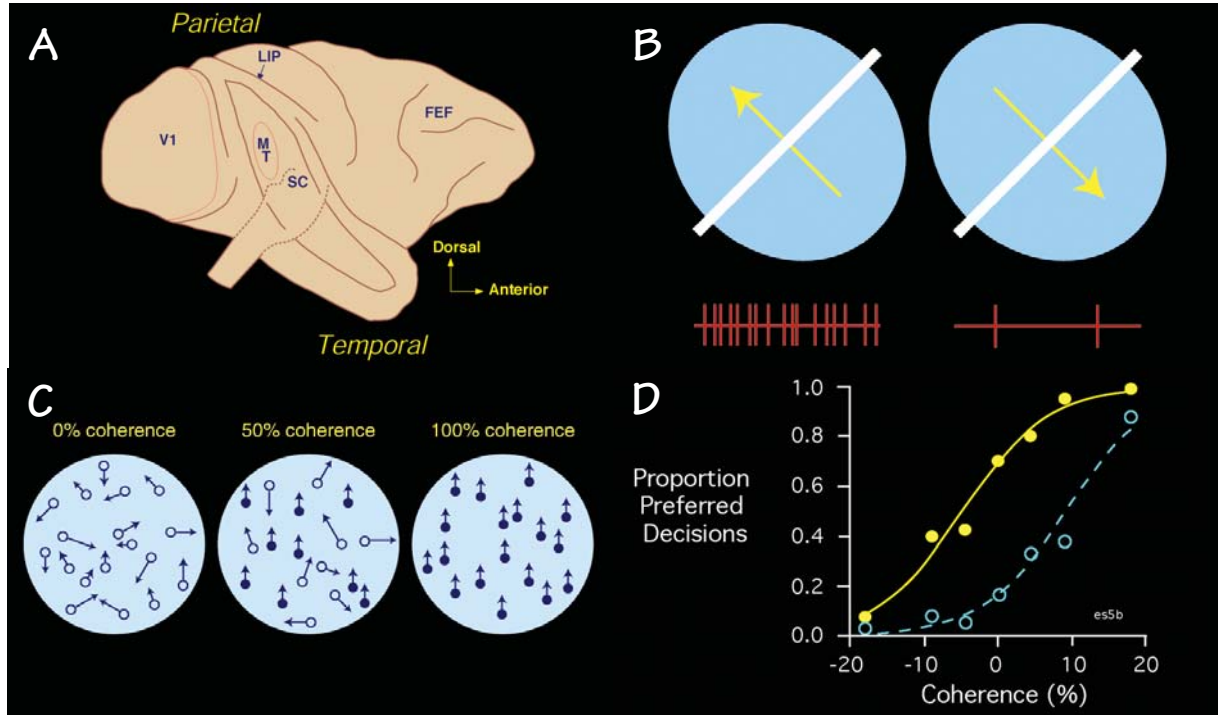

Motion sensitivity. A. A side-view of the a monkey's brain with the primary visual cortex (V1) at the left and an area called MT (sometimes called V5) in which motion-sensitive neurons are found. B. A motion-sensitive neuron in which action potentials (vertical red lines) occur frequently in response to motion in the northwest direction, but rarely in the opposite direction. Different columns of cells in MT (or V5) code for different directions of movement. C. A circular TV screen used in experiments on motion sensitivity in which dots move about in random directions (0% coherence) or all in one direction (100% coherence). D. The monkey's indication of the likely direction of the dots increases as their coherence increases (yellow line). Electrical microstimulation of the columns of different orientations shifts the estimate of preferred direction (blue line).

Neurons in one of these areas, area **MT** or **V5**, have been recorded in a monkey, while it makes a simple visual decision about a pattern of moving dots. Most of the dots are made to move randomly in different directions but a small fraction of them are moving consistently in a single direction - up, down, left or right. The observer has to judge the overall direction of movement of the pattern. The task can be made very *easy* by arranging for a large percentage of the dots to be moving consistently in one direction, as opposed to randomly, or *harder* by decreasing the proportion of dots that move consistently. It turns out that activity of cells in V5 accurately reflects the strength of the movement signal. Neurons here respond selectively to particular directions of movement, increasing their activity systematically and accurately when the proportion of dots moving in their preferred motion direction increases.

Amazingly, some **individual** neurons perform just as well at detecting the movement of dots as is an observer, whether a monkey or a human, at making a behavioural judgement. Microstimulation of such neurons through the recording electrode can even bias the judgement of relative movement that the monkey is making. This is remarkable given that very large numbers of neurons are sensitive to visual motion and one might have expected decisions to be based on the activity of many neurons rather than just a few. Decisions about colour proceed in a similar way (see Research Frontiers Box - above).

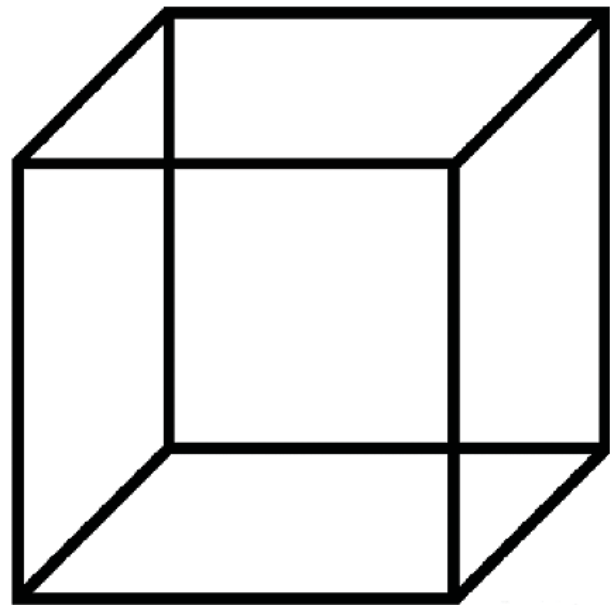

The Necker cube is constantly reversing perceptually. The retinal image doesn't change, but we see the cube first with the top left corner nearer to us and then as if it is receding. Rarely, it is even seen as a set of intersecting lines on a flat surface. There are many types of reversible figure, some of which have been used to explore the neural signals involved when the visual brain makes decisions about which configuration is dominant at any one time.

Research Frontiers

Colour sensitive cells. Certain neurons show different patterns of activity to different wavelengths of light. Some respond best to long wavelengths, others to short. You might think this would be enough to perceive colour, but this may not be so. Compare the cell firing on the left to that on the right. Can you tell the difference?

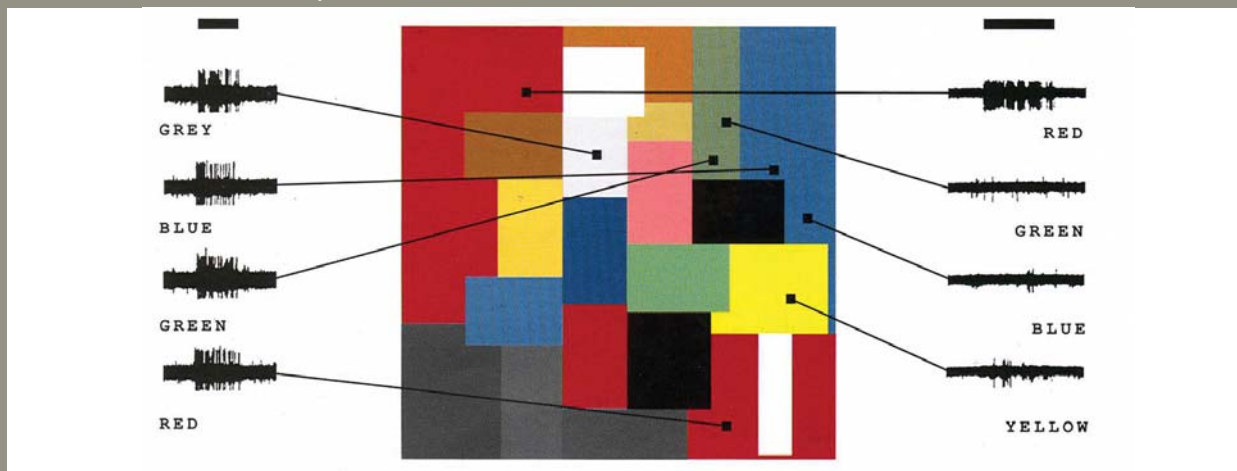

Left. Clever design of a coloured patchwork called a Mondrian (after the artist Piet Mondrian). This is illuminated with different combinations of long, middle and short wavelength light so that each panel in turn reflects exactly the same mixture of light, even though we always perceive them as being different colours because of the presence of the surrounding patches. The cell on the left, recorded in V1, fires about the same extent in all cases. It does not "perceive" colour, it simply responds to the identical wavelength mixture reflected from each patch.

Right. A true colour-sensitive cell in V4 fires to an area of the Mondrian that we see as red, but much less to other areas. This differential response occurs even though the same triplet of wave energies was reflected from each. V4 may therefore be the area of the brain that enables us to perceive colour, though some neuroscientists suspect it is not the only area involved.

Believing is seeing

Area V5 does more than just register the motion of visual stimuli, it registers perceived motion. If visual tricks are played such that an area of dots are perceived as moving in one direction or another only by virtue of the motion of surrounding dots, i.e. an illusion of movement, the neurons corresponding to the area of the illusion will fire differently to rightwards or leftwards perceived movement. If the movement is completely random, neurons that normally prefer rightwards movement fire slightly more on trials when the observer reports that the random motion signal is moving "rightwards" (and vice versa). The difference between neuronal decisions of "rightwards" or "leftwards" reflects what the observer judges about the appearance of motion, not the absolute nature of the moving stimulus.

Other examples of visual decision and indecision include reactions to perceptual targets that are genuinely ambiguous, such as the so-called **Necker cube** (Figure). With this type of stimulus the observer is placed in a state of indecision, constantly fluctuating from one interpretation to another. A similar rivalry is experienced if the left eye sees a pattern of vertical lines while the right eye sees a pattern of horizontal lines. The resulting percept is termed **binocular rivalry**, as the observer reports first that the vertical lines dominate, then the horizontal lines and then back again to vertical. Once again, neurons in many different areas of the visual cortex reflect when the observer's perception switches from horizontal to vertical.

Our visual world is an astonishing place. Light entering the eyes enables us to appreciate the world around us ranging from the simplest of objects through to works of art that dazzle and beguile us. Millions and millions of neurons are involved, with their duties ranging from the job of a retinal photoreceptor responding to a speck of light through to a neuron in area V5 that decides whether something in the visual world is moving. All of this happens apparently effortlessly within our brains. We don't understand it all, but neuroscientists are making great strides.

Colin Blakemore has contributed to understanding how the visual system develops. This includes pioneering studies using cell-culture to study interactions between different parts of a pathway in the embryonic brain (left). On the right, we see axons (stained green) growing down from the developing cortex to meet other fibres (stained orange) that perform a "handshake" before growing up to the cortex.



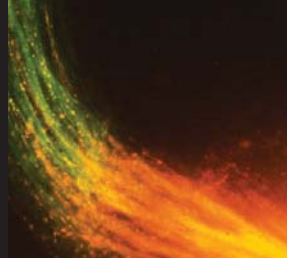

Movement

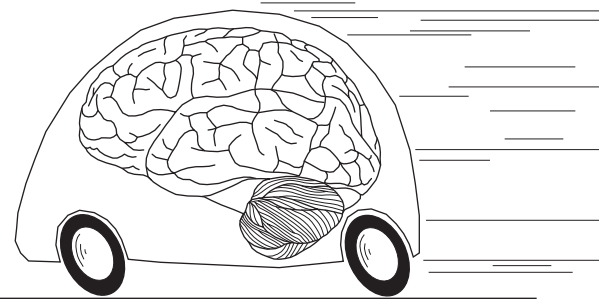

Think about catching a ball. Easy? It may seem so, but to perform even this simple movement, your brain has to do some remarkable things. We take it all for granted, yet there is the planning: Is the ball light or heavy? From what direction is it coming and how fast will it be going? There is the coordination: How does one automatically coordinate one's limbs for catching and what way would be best? And there is the execution: Does your arm get to the right place and do your fingers close at the right time? Neuroscientists now know that there are many areas of the brain that get involved. Neural activity in these areas combines to form a loose chain of command – a motor hierarchy – from the cerebral cortex and basal ganglia to the cerebellum and spinal cord.

The neuromuscular junction

At the lowest extreme of the motor hierarchy, in the spinal cord, hundreds of specialised nerve cells called motor neurons increase their rate of firing. The axons of these neurons project out to the muscles where they activate contractile muscle fibres. The terminal branches of the axons of each motor neuron form specialised **neuromuscular junctions** on to a limited number of muscle fibres within one muscle (see Figure below). Each action potential in a motor neuron causes the release of neurotransmitter from nerve endings and generates a corresponding action potential in the muscle fibres. This causes Ca^{2+} ions to be released from intracellular stores inside each muscle fibre. This in turn triggers contraction of the muscle fibres, producing force and movement.

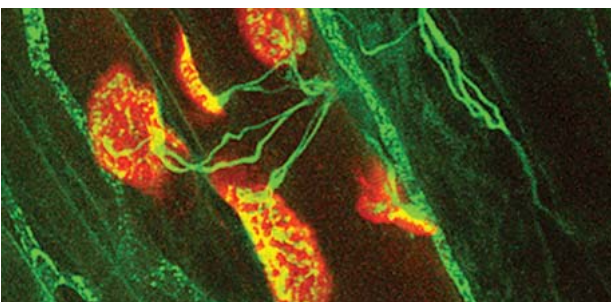

To make muscles contract, the nerves form specialized contacts with individual muscle fibres at the neuromuscular junction. As they develop, multiple nerve fibres go to each muscle fibre but, due to competition between neurons, all but one is eliminated. The final successful nerve is then left to release its neurotransmitter acetylcholine on to specialised molecular detectors at the "motor endplate" (stained red). This image was made using a confocal microscope.

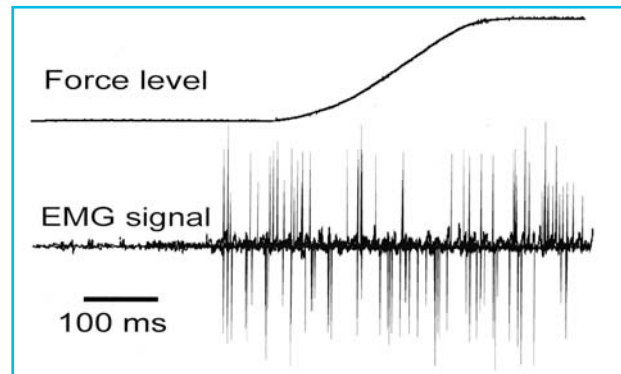

Recordings of the electrical activity associated with muscles (electro-myographic activity).

The electrical events in the muscles of the arm can be recorded with an amplifier, even through the skin, and these electro-myographic recordings (**EMGs**) can be used to measure the level of activity in each muscle (see Fig. above).

The spinal cord plays an important part in the control of the muscles through several different reflex pathways. Among these are the withdrawal reflexes that protect you from sharp or hot objects, and the stretch reflexes that have a role in posture. The well-known 'knee-jerk' reflex is an example of a stretch reflex that is rather special because it involves only two types of nerve cell – sensory neurons that signal muscle length, connected through synapses to motor neurons that cause the movement. These reflexes combine together with more complex ones, in spinal circuits that organise more or less complete behaviours, such as the rhythmic movement of the limbs when walking or running. These involve coordinated excitation and inhibition of motor neurons.

Motor neurons are the **final common path** to the muscles that move your bones. However, the brain has a major problem controlling the activity of these cells. Which muscles should it move to achieve any particular action, by how much, and in what order?

The top of the hierarchy - the motor cortex

At the opposite end of the motor hierarchy, in the cerebral cortex, a bewildering number of calculations have to be made by many tens of thousands of cells for each element of movement. These calculations ensure that movements are carried out smoothly and skilfully. In between the cerebral

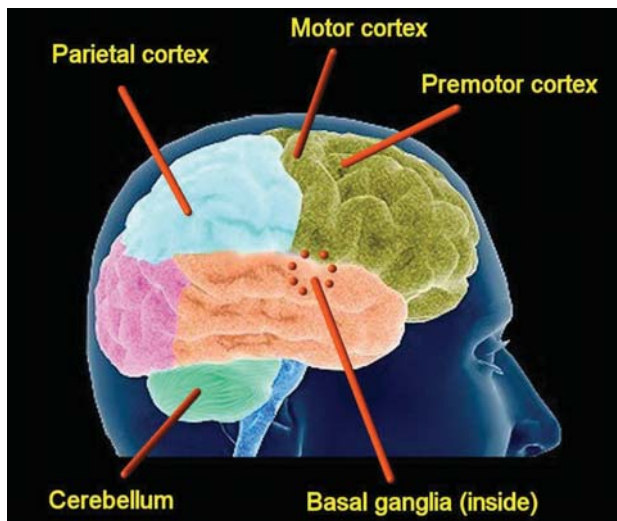

The several regions of the brain involved in controlling movements.

cortex and motor neurons of the spinal cord, critical areas in the brain stem combine information about the limbs and muscles ascending from the spinal cord with descending information from the cerebral cortex.

The **motor cortex** is a thin strip of tissue running across the surface of the brain, directly in front of the somatosensory cortex (see p.12). Here is a complete map of the body: nerve cells that cause movements in different limbs (via connections onto the motor neurons in the spinal cord) are topographically arranged. By using a recording electrode, neurons may be found in any part of this map that are active about 100 milliseconds before activity in the appropriate muscles. Quite what is coded in the motor cortex was the subject of a long debate - do the cells in the cortex code for actions that a person wants to perform or for the individual muscles that must be contracted to perform it. The answer to this question turned out to be somewhat different - individual neurons do not code for either. Instead a **population code** is used in which actions are specified by the firing of an ensemble of neurons.

Just in front of the motor cortex lie important pre-motor areas that are involved in planning actions, in preparing spinal circuits for movement, and in processes that establish links between seeing movements and understanding gestures. Striking new findings include the discovery of **mirror neurons** in monkeys that respond both when the monkey sees a hand movement and when the animal performs that same movement. Mirror neurons are likely to be important in imitating and understanding actions. Behind the motor cortex, in the parietal cortex, a number of different cortical areas are concerned with the spatial representation of the body and of visual and auditory targets around us. They seem to hold a map of where our limbs are, and where interesting targets are with respect to us. Damage to these areas, for example

“...mirror neurons will do for psychology what DNA did for biology: they will provide a unifying framework and help explain a host of mental abilities that have hitherto remained mysterious and inaccessible to experiments. They are the great leap forward of primate brain evolution”. V.S.Ramachandran



An Experiment on Movement

Who moves me? Try this experiment with a friend. Pick up a fairly heavy book on the palm of your right hand. Now lift the book from your right hand with your left. Your task is to keep your right hand still! You should find this easy. Now try again, keeping your hand absolutely still while your friend lifts the book off your hand. Few people can do that. Don't worry; it takes very many trials to be able to get even close to the performance you found easy when you did it yourself.

This experiment illustrates that the sensorimotor areas of your brain have more knowledge about what you do entirely yourself than it receives when you watch others give the trigger for your actions.



after a stroke, can cause misreaching for objects or even neglect or denial of parts of the world around us. Patients with so-called **parietal neglect** fail to notice objects (often on their left side) and some even ignore the left side of their own body.

The basal ganglia

The **basal ganglia** are a cluster of interconnected areas located beneath the cortex in the depths of the cerebral hemispheres. They are crucial in the initiation of movements,

though quite how they do this is far from clear. The basal ganglia seem to act rather like a complex filter, selecting information from amongst the enormous numbers of diverse inputs they receive from the anterior half of the cortex (the sensory, motor, prefrontal and limbic regions). The output of the basal ganglia feeds back to the motor cortical areas.

A common human motor disorder, **Parkinson's disease**, is characterised by tremor and difficulty in initiating movements. It is as if the selective filter in the basal ganglia is blocked. The problem is the degeneration of neurons in an area of the brain called the substantia nigra (so-called because it is black in appearance) whose long, projecting axons release the neurotransmitter dopamine into the basal ganglia (see Research Frontiers box below). The precise arrangement of the **dopamine** axons onto their target neurons in the basal ganglia is very intricate, suggesting an important interaction between different neurotransmitters. Treatment with the drug L-Dopa, which is converted into dopamine in the brain, restores dopamine levels and restores movement (see Chapter 16).

The basal ganglia are also thought to be important in learning, allowing the selection of actions that lead to rewards.

The cerebellum

The **cerebellum** is crucial for skilful smooth movements. It is a beautiful neuronal machine whose intricate cellular architecture has been mapped out in great detail. Like the basal ganglia, it is extensively interconnected with the cortical areas concerned with motor control, and also with brainstem structures. Damage to the cerebellum leads to poorly coordinated movements, loss of balance, slurred speech, and also a number of cognitive difficulties. Sounds familiar? Alcohol has a powerful effect on the cerebellum.

The cerebellum is also vital for motor learning and adaptation. Almost all voluntary actions rely on fine control of motor circuits, and the cerebellum is important in their optimal adjustment - for example with respect to timing. It has a very regular cortical arrangement and seems to have evolved to bring together vast amounts of information from the sensory systems, the cortical motor areas, the spinal cord and the brainstem. The acquisition of skilled movements depends on a cellular learning mechanism called long-term depression (LTD), which reduces the strength of some synaptic connections (see chapter on Plasticity). There are a number of theories of cerebellar function; many involve the idea that it generates a "model" of how the motor systems work - a kind of virtual reality simulator of your own body, inside your head. It builds this model using the synaptic plasticity that is embedded into its intricate network. So, catch that ball again, and realise that almost all levels of your motor hierarchy are involved - from planning the action in relation to the moving visual

target, programming the movements of your limbs, and adjusting the postural reflexes of your arm. At all stages, you would need to integrate sensory information into the stream of signals leading to your muscles.

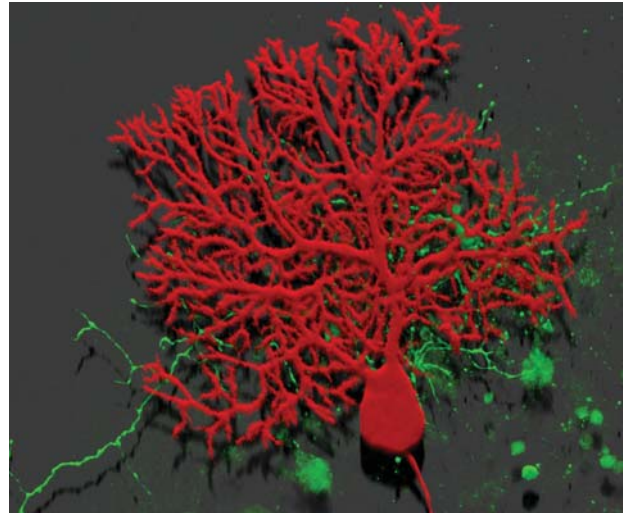

A Purkinje cell of the cerebellum showing the extensive 'arborisation' of its dendritic tree. This serves to receive the myriad of inputs required for the precise timing of skilled movements that we learn.



Research Frontiers

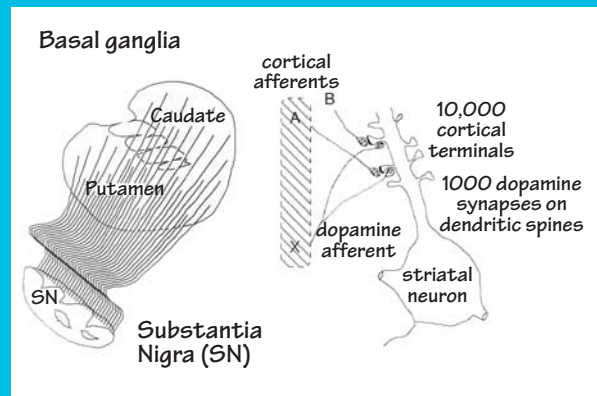

An unexpected story about dopamine

The chemistry underlying actions and habits involves the neurotransmitter dopamine that is released on to neurons in the basal ganglia where it acts at metabotropic receptors (Chapter 3). There it serves as both an incentive to act and as a reward signal for acting appropriately. An intriguing new discovery is that the release of dopamine is highest when the reward is unexpected. That is, the dopamine neurons fire most strongly at a stage of learning when it really helps to give a strong reinforcement to the motor system for having produced the right output. Movements can then be strung together in a sequence through the release of successive bursts of dopamine. Later on, particularly if complex movements become habitual, the system free-runs without the dopamine reward. At this point, particularly if movements have to be accurately timed, the cerebellum starts to play a role.



The Developing Nervous System



The basic plan of the brain is virtually identical from person to person and recognisably similar across all mammals. It is largely genetically determined, but fine details of the networks are influenced by the electrical activity of the brain, especially during early life. Such is its complexity, we are still far from a complete understanding of how the brain develops, but clear insights have emerged in recent years by virtue of the genetic revolution.

Take one fertilised egg, and then follow the instructions

The human body and brain develop from a single cell - the fertilized egg. But how? The governing principle of developmental biology is that the **genome is a set of instructions** for making an organ of the body, not a blueprint. The genome is the 40,000 or so genes that orchestrate the process. Carrying out these instructions is a bit like the Chinese art of paper folding - a limited set such as fold, bend and unfold produces a structure that would take many drawings to describe as a blueprint. Beginning with the embryo, a comparatively small set of genetic instructions is able to generate the huge diversity of cells and connections of the brain during development.

Amazingly, many of our genes are shared with the fruit fly, **Drosophila**. Indeed, thanks to studies of the fruit fly, the majority of the genes known to be important in human nervous system development were first identified. Neuroscientists studying brain development examine a wide variety of animals - **zebrafish, frog, chick and mouse** - each having advantages for examining particular molecular or cellular events. The zebrafish embryo is transparent - allowing each cell to be watched under the microscope as it develops. The mouse breeds rapidly - its genome has been mapped and almost completely sequenced. Chicks and frogs are less amenable to genetic studies, but their large embryos allow microsurgical manipulations - such as examining what happens when cells are moved to abnormal positions.

First steps...

The first step in brain development is cell division. Another key step is cell differentiation in which individual cells stop dividing and take on specific characteristics - such as those of neurons or glial cells. Differentiation orders things spatially. Different kinds of neurons migrate to various locations in a process called pattern formation.

The first major event of pattern formation takes place in the third week of human gestation when the embryo is just two

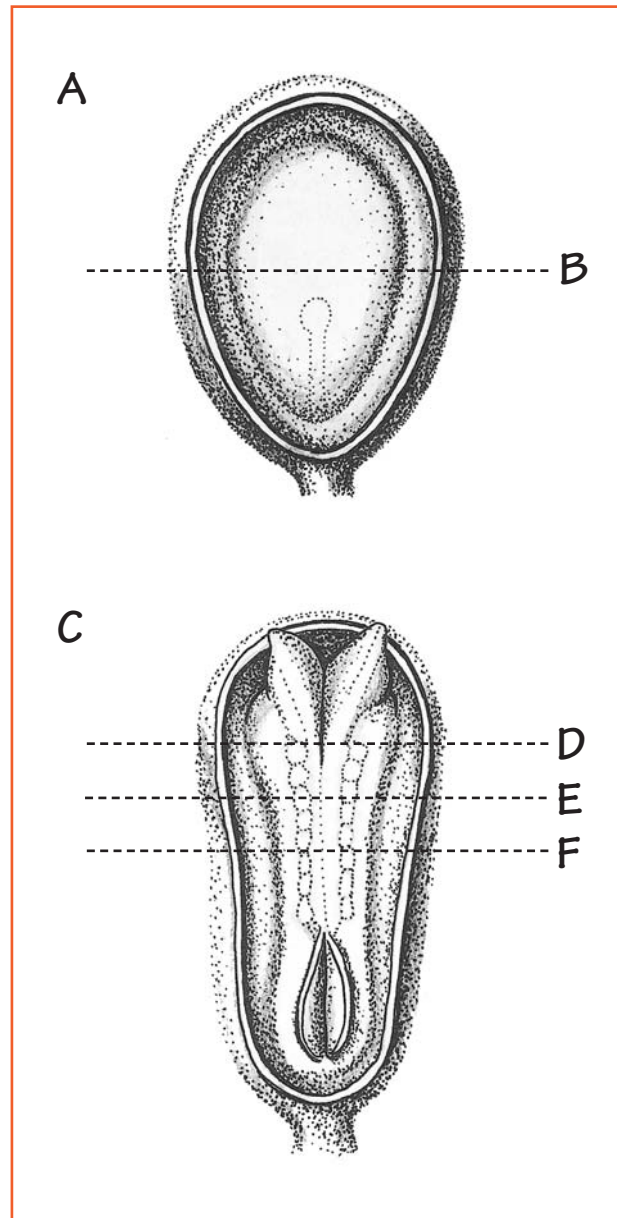

The neural plate folds into the neural tube. A. A human embryo at 3 weeks after conception. B. The neural plate forming the top (dorsal) surface of the embryo. C. A few days later, the embryo develops enlarged head folds at the front (anterior) end. The neural plate remains open at both head and tail ends but has closed in between. D, E, F. Different levels of the axis from head to tail showing various stages in neural tube closure.

connected sheets of dividing cells. A small patch of cells on the upper surface of the bilayer is instructed to make the entire brain and spinal cord. These cells form a tennis racket-shaped structure called the **neural plate**, the front of which is destined to form the brain, the rear to be the spinal cord. Signals directing the destiny of these cells come from the layer beneath that goes on to form the midline skeleton and muscles of the embryo. Various regions of the early nervous system express different subsets of genes, presaging the emergence of brain areas - forebrain, midbrain and hindbrain - with distinct cellular architecture and function.

Rolling around

A week later, the neural plate rolls up, closes into a tube and sinks into the embryo, where it becomes enveloped by the future epidermis. Further profound changes happen in the next few weeks, including changes in cell shape, division and migration, and cell-cell adhesion. For example, the neural tube flexes such that the head region is bent at right angles to the trunk region. This patterning progresses to finer and

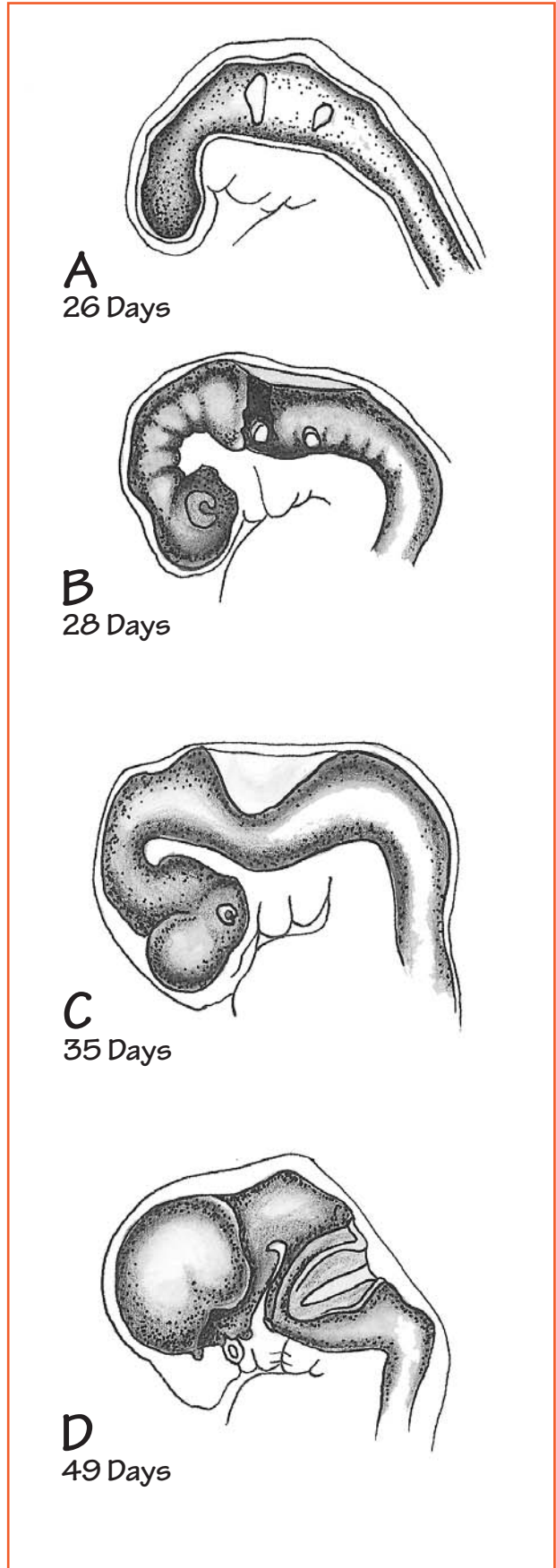
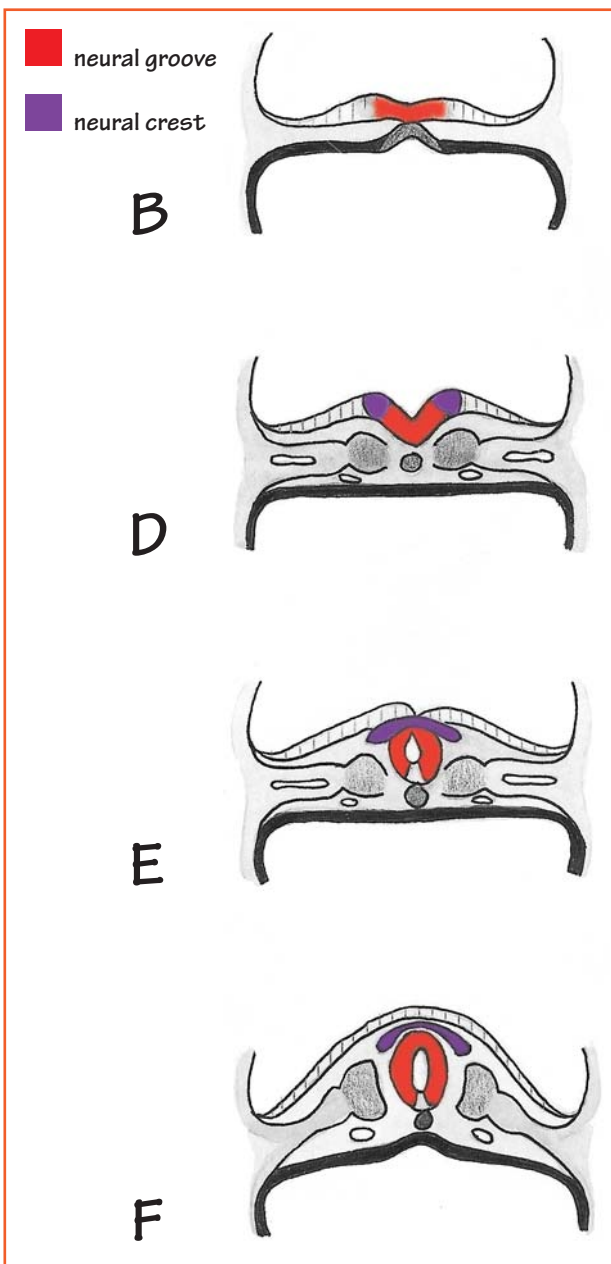

The morphogenesis of the human brain between (a) 4 weeks, and (d) 7 weeks after conception. Different regions expand and there are various flexures along the head-tail axis.

finer levels of resolution, ultimately conferring **individual identity** on to young neurons. Things can go wrong. Failure of the neural tube to close results in **spina bifida**, a condition that is usually confined to the lower spinal cord. While distressing, it is not lifethreatening. By contrast, failure of closure at the head end can result in the complete absence of an organised brain, a condition known as **anencephaly**.

Know your position in life

The underlying principle of patterning is that cells get to know their position relative to the principal axes of the nervous system - front to back and top to bottom. In effect, each cell measures its position with respect to these orthogonal coordinates much as a map-reader figures out his or her position by measuring distance from defined points. The way this works at the molecular level is that the embryo sets up a number of localised **polarizing** regions in the neural tube that secrete signal molecules. In each case, the molecule diffuses away from its source to form a **gradient** of concentration with distance. An example of this position-sensing mechanism is the top to bottom (dorsoventral) axis of the spinal cord. The bottom part of the neural tube expresses a secreted protein with a wonderful name - **Sonic hedgehog**. Sonic hedgehog diffuses away from the floor plate and affects cells on the dorsoventral axis according to their distance from the floor plate. When close, Sonic hedgehog induces the expression of a gene that makes a particular type of interneuron. Further away, the now lower concentration of Sonic hedgehog induces expression of another gene making motor neurons.

Staying put or knowing where you are going

Once a neuron acquires its individual identity and stops dividing, it extends its axon with an enlarged tip known as a **growth cone**. A bit like a nimble mountain guide, the growth cone is specialized for moving through tissue, using its skills to select a favourable path. As it does so, it plays out the axon behind it, rather like a dog on an extending leash. Once its target has been reached the growth cone loses its power of movement and forms a **synapse**. **Axonal guidance** is a supreme navigational feat, accurate over short and long distances. It is also a very single-minded process for not only is the target cell selected with high precision but, to get there, the growth cone may have to cross over other growth cones heading for different places. Along the path, guidance cues that attract (+) or repel (-) the growth cones help them find their way, although the molecular mechanisms responsible for regulating the expression of these cues remain poorly understood.

Sculpting by electrical activity

Although a high degree of precision in both the spatial arrangement of neurons and their connectivity is achieved from the outset, the wiring of some parts of the nervous system is later subject to **activity-dependent refinement**, such as the pruning of axons and the death of neurons. These losses may appear wasteful, but it is not always possible or desirable to make a complete and perfect brain by construction alone. Evolution has been said to be "a tinkerer" - but it is also a sculptor. For example, point-to-

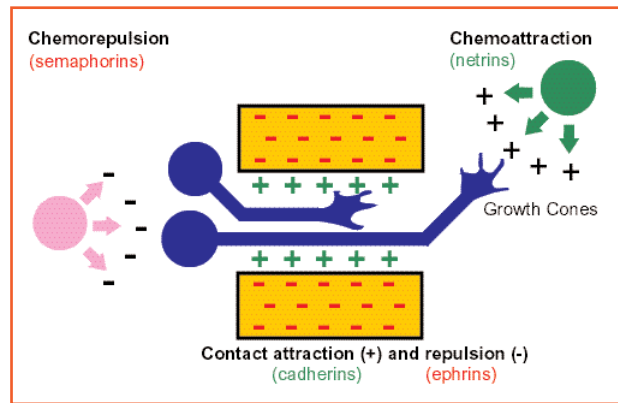

Various types of guidance cues encountered by neurons (blue) as they extend their axons and growth cones (spikes at the front end). Both local and distant cues can be attractive to the growth cone (+) or repulsive (-). Some examples are given of specific molecular guidance cues.

point mapping between neurons in the eye and the brain, absolutely required for sharp vision, is achieved in part through the influence patterned **electrical activity** in the retina. Also, an initial exuberant set of connections is sculpted during a **critical period**, after which the basic pattern of the visual system is complete, at around eight weeks of age in monkeys, perhaps a year in humans. An intriguing question is whether such early developmental programs can ever be re-activated in cases of pathological neuronal loss (such as in Alzheimer and Parkinson's diseases) or of spinal cord damage that results in paralysis. In the latter, axons can be encouraged to re-grow following injury but whether they can be made to re-connect appropriately remains an area of intense investigation.

The genomic revolution

We are rapidly acquiring a complete catalogue of the genes needed to build a brain. Thanks to the prodigious power of molecular biological methods, we can test the function of genes by modulating their expression wherever and whenever we want during development. The major task now is to work out the hierarchy of genetic control that converts a sheet of cells into a working brain. It is one of the grand challenges of neuroscience.

Research Frontiers

Stem cells are cells of the body with the potential to change into all sorts of different kinds of other cells. Some, called embryonic stem cells, proliferate very early in development. Others are found in bone marrow and in the umbilical cord that connects a mother to her newborn baby. Neuroscientists are trying to find out if stem cells can be used to repair damaged neurons in the adult brain. Most of the work at the moment is being done with animals, but the hope is that we may eventually be able to repair areas of the brain damaged by diseases such as Parkinson's Disease.

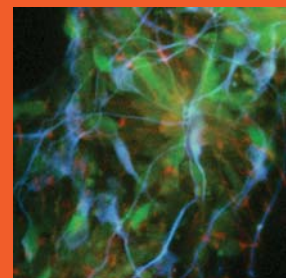

Dyslexia

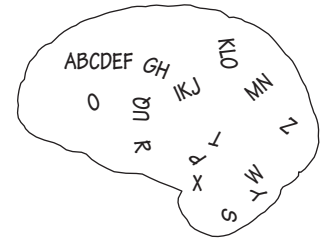

Do you remember how difficult it was to learn to read? Unlike speaking, whose evolutionary origins are very old, reading and writing are relatively recent human inventions. It may only have been a thousand years ago that communities in scattered parts of the world realised that the thousands of spoken words are made up of a smaller number of separate sounds (44 phonemes in English) and that these can be represented by an even smaller number of visual symbols. Learning these symbols takes time and some children experience exceptional difficulties. This is not through any lack of intelligence but because their brains find the particular requirements of reading difficult to master. As many as 1 in 10 of us may have had this condition, now known by its neurological name, developmental dyslexia.

Dyslexia is very common. As children who have it cannot understand why they find reading so difficult when they know they are as intelligent as friends who find it easy, dyslexia is a real cause of misery. Many children lose confidence, and this can lead to a downward spiral of frustration, rebellion, aggression and even delinquency. Yet many dyslexics go on to display great talents in other spheres - sport, science, computing, commerce or the arts - provided their early problems with reading have not caused them to lose all hope and self-esteem. Hence understanding the biological basis of dyslexia is not only important in itself, but also a contribution to preventing a burden of misery. Understanding the process of reading better may lead us to a way of overcoming or treating the problem.

Learning to read

Reading depends on being able to recognise alphabetic visual symbols in their right order - the **orthography** of whatever language a child is learning - and to hear the separate sounds in words in their right order. This involves extracting what is called the **phonemic structure**, so that the symbols can be translated into the correct sounds. Unfortunately most dyslexics are slow and inaccurate at analysing both the orthographic and phonological features of words.

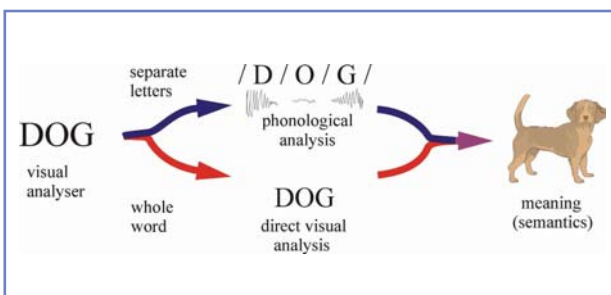

The ability to sequence letters and sounds accurately depends on both visual and auditory mechanisms. For unfamiliar words, and all are unfamiliar to the beginning reader, each letter has to be identified and then to be put in the right order. This process is not as easy as it sounds, because the eyes make small movements flicking from one letter to the next. The letters are identified during each fixation of the eye but their order is given by where the eye was pointing when each letter was seen. What the eyes see has to be integrated with motor signals from the eye movement system; and it is with this visuomotor integration that many dyslexics have problems.

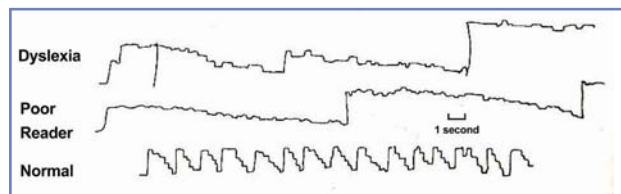

Eye movements during reading. Up and down movements of the pen recorder correspond to left and right.

Visual control of the eye movement system is dominated by a network of large neurons known as the **magnocellular system**. It gets this name because the neurons (cells) are very large (magno). This network can be traced right from the retina, through the pathway to the cerebral cortex and cerebellum, to the motor neurons of the eye-muscles. It is specialised to respond particularly well to moving stimuli and it is therefore important for tracking moving targets. An important feature of this system is that it generates motion error signals, during reading, when the eyes move off letters they are meant to be fixating. This **motion error signal** is fed back to the eye-movement system to bring the eyes back on target. The magnocellular system plays a crucial part in helping to point the eyes steadily at each letter in turn, and hence in determining their order.

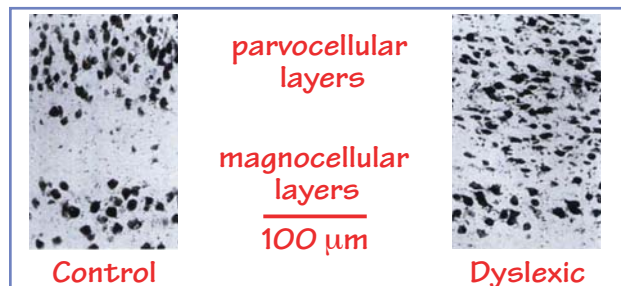

Histological stain of the lateral geniculate nucleus showing well organized parvo and magnocellular cells in a normal person and disorganization in some kinds of dyslexia.

Neuroscientists have found that the visual magnocellular system is mildly impaired in many dyslexics. Looking at brain tissue directly is one way to reveal this (Figure) but, in addition, the sensitivity to visual motion of dyslexics is poorer than that of normal readers and their brain wave responses to moving stimuli are abnormal. Brain imaging has also revealed altered patterns of functional activation in regions sensitive to visual motion (see Chapter 15 on Brain Imaging). The control of the eye in dyslexics is less steady; hence they often complain that letters seem to move around and change places when they are trying to read. These visual confusions are probably the result of the visual magnocellular system failing to stabilise their eyes as well as it does in good readers.

Putting sounds into the right order

Many dyslexics also have problems putting the sounds of words in the right order so that they tend to mispronounce words (such as pronouncing **lollypop** as **pollylop**) and they are very bad at tongue twisters. When they come to reading, they are slower and more inaccurate at translating letters into the sounds they stand for. Like their visual problems, this phonological deficiency is probably rooted in a mild deficiency of basic auditory skills.

We distinguish letter sounds, called **phonemes**, by detecting the subtle differences in the sound frequency and intensity changes that characterise them. Detecting these acoustic modulations is carried out by a system of large auditory neurons that track changes in sound frequency and intensity. There is growing evidence that these neurons fail to develop as well in dyslexics as in good readers and that the categorical boundaries between similar sounds, such as 'b' and 'd', are harder for them to hear (see Figure).

Many dyslexics show evidence of impaired development of brain cells, extending beyond the visual and auditory problems they have with reading. These are problems in neurons that form networks throughout the brain that seem to be specialised for tracking temporal changes. The cells all have the same surface molecules by which they recognise and form contacts with each other, but which may make them vulnerable to antibody attack.

The magnocellular system provides a particularly large input to the cerebellum (see Chapter 7 on Movement). Interestingly, some dyslexics are remarkably clumsy and

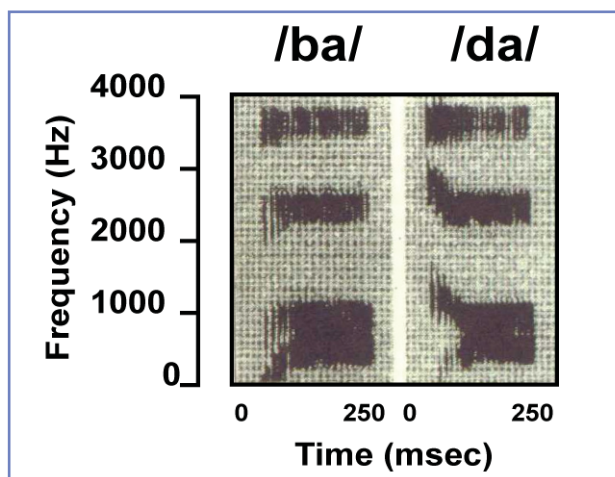

their handwriting is often very poor. Neuroimaging (see p.41) and metabolic studies of the cerebellum have indicated that its function can be impaired in dyslexics and this may be at the root of their difficulties with handwriting. Some neuroscientists believe the cerebellum is involved in much more than the execution of movements such as writing and speaking, even including aspects of cognitive planning. If correct, deficits in cerebellar function could add to problems with learning to read, write and spell.

What can be done?

There are a number of treatments for dyslexia, each indicated by the different hypotheses about its underlying cause. Some focus on the magnocellular hypothesis, but other accounts distinguish different forms of the acquired condition, known as surface and deep dyslexia, which may require different kinds of treatment. All treatments rely on early diagnosis.

Scientists do not always agree on things and the best treatment for dyslexia is one such area of disagreement. It has been suggested recently that problems in sound processing result in some dyslexics going down the wrong path for learning about sounds using the brain's normal mechanisms of plasticity. The idea is that children can get back on the 'straight and narrow' if they are encouraged to play computer games in which they hear sounds that have been slowed down to the point where phonemic boundaries are much clearer. The sounds are then gradually speeded up. It is claimed that this works very well, but independent tests are still being done. What is scientifically interesting about the idea is that perfectly normal brain processes interact with an early genetic abnormality to produce an exaggerated effect. It's a striking example of how genes and the environment can interact.

It is important to stress that dyslexics may be slightly better than even good readers at some perceptual judgements such as colour distinctions and global, rather than local, shape discriminations. This hints at a possible explanation of why many dyslexics may be superior in seeing long-range associations, unexpected associations and at 'holistic' thinking in general. Remember that **Leonardo da Vinci**, **Hans Christian Andersen**, **Edison** and **Einstein** and many other creative artists and inventors were dyslexic.

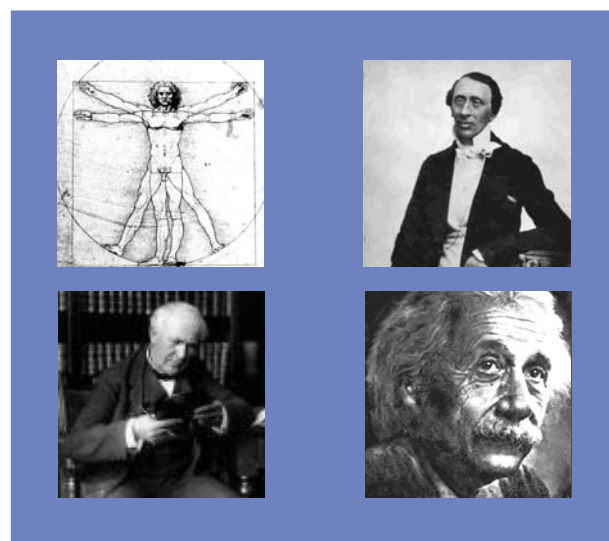

Plasticity

Throughout our lives our brains constantly change. This ability of the brain to change is called plasticity - by analogy with plasticine model whose internal components can be constantly re-shaped. Not the brain as a whole, but the individual neurons can be modified for different reasons - during development when we are young, in response to brain injury, and during learning. There are various mechanisms of plasticity, of which the most important is synaptic plasticity - the science of how neurons alter their ability to communicate with one another.

Moulding our futures

As we saw in the last chapter, the connections between neurons early in life require fine-tuning. As we interact with our environment, these synaptic connections start to change - with new ones being made, useful connections becoming stronger, and connections that are infrequently used becoming weaker or even lost for good. Synapses that are active and those that are actively changing are kept while the rest are pruned. This is a kind of **use it or lose it** principle by which we mould the future of our brains.

Synaptic transmission involves the release of a chemical neurotransmitter that then activates specific protein molecules called receptors. The normal electrical response to neurotransmitter release is a measure of **synaptic strength**. This can vary and the change may last for a few seconds, a few minutes or even for a lifetime. Neuroscientists are particularly interested in long-lasting changes in synaptic strength that can be produced by brief periods of neuronal activity, notably in two processes called **long-term potentiation (LTP)**, which enhances their strength, and **long-term depression (LTD)**, which depresses them.

A flavour of how it all works

Glutamate is a common amino acid used throughout our bodies to build proteins. You may have come across it as the flavour enhancer called mono-sodium glutamate. It is the neurotransmitter that functions at the most plastic synapses of our brains - those that exhibit LTP and LTD. Glutamate receptors, which are mainly on the receiving side of the synapse, come in four varieties: three are ionotropic receptors and have been given the names **AMPA**, **NMDA** and **kainate**. The fourth type is metabotropic and is called **mGluR**. Although all the types of glutamate receptors respond to the same neurotransmitter, they perform very different functions. The ionotropic glutamate receptors use their ion channels to generate an excitatory post-synaptic potential (epsp) while the metabotropic glutamate receptors, like the neuromodulatory actions we described earlier (p. 8), modulate the size and nature of this response. All types are important for synaptic plasticity, but it is the AMPA and NMDA receptors about which we know the most and that are often thought of as **memory molecules**. Much of this knowledge has come about because of pioneering work developing new drugs that act on these receptors to modify their activity (see box p. 29).

AMPA receptors are fastest into the act. Once glutamate is bound to these receptors, they rapidly open their ion channels to produce a transient excitatory postsynaptic potential (epsp) as described in Chapter 3). The glutamate is only bound to AMPA receptors for a fraction of a second and, once it leaves and is removed from the synapse, the ion channels close and the electrical potential reverts to its resting state. This is what happens when neurons in the brain send information to each other quickly.

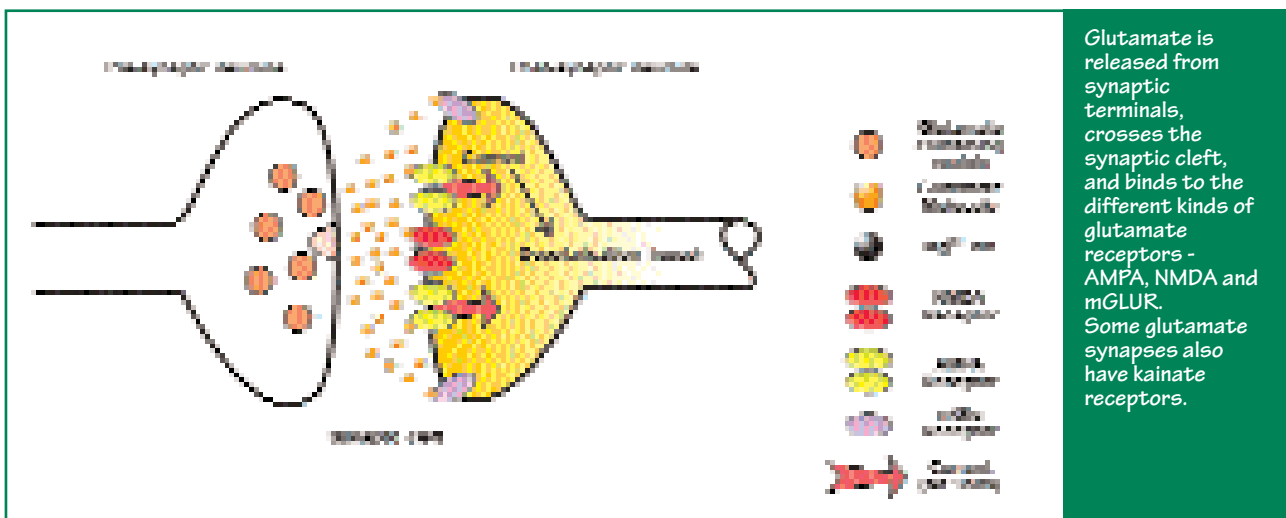

Glutamate is released from synaptic terminals, crosses the synaptic cleft, and binds to the different kinds of glutamate receptors - AMPA, NMDA and mGluR. Some glutamate synapses also have kainate receptors.

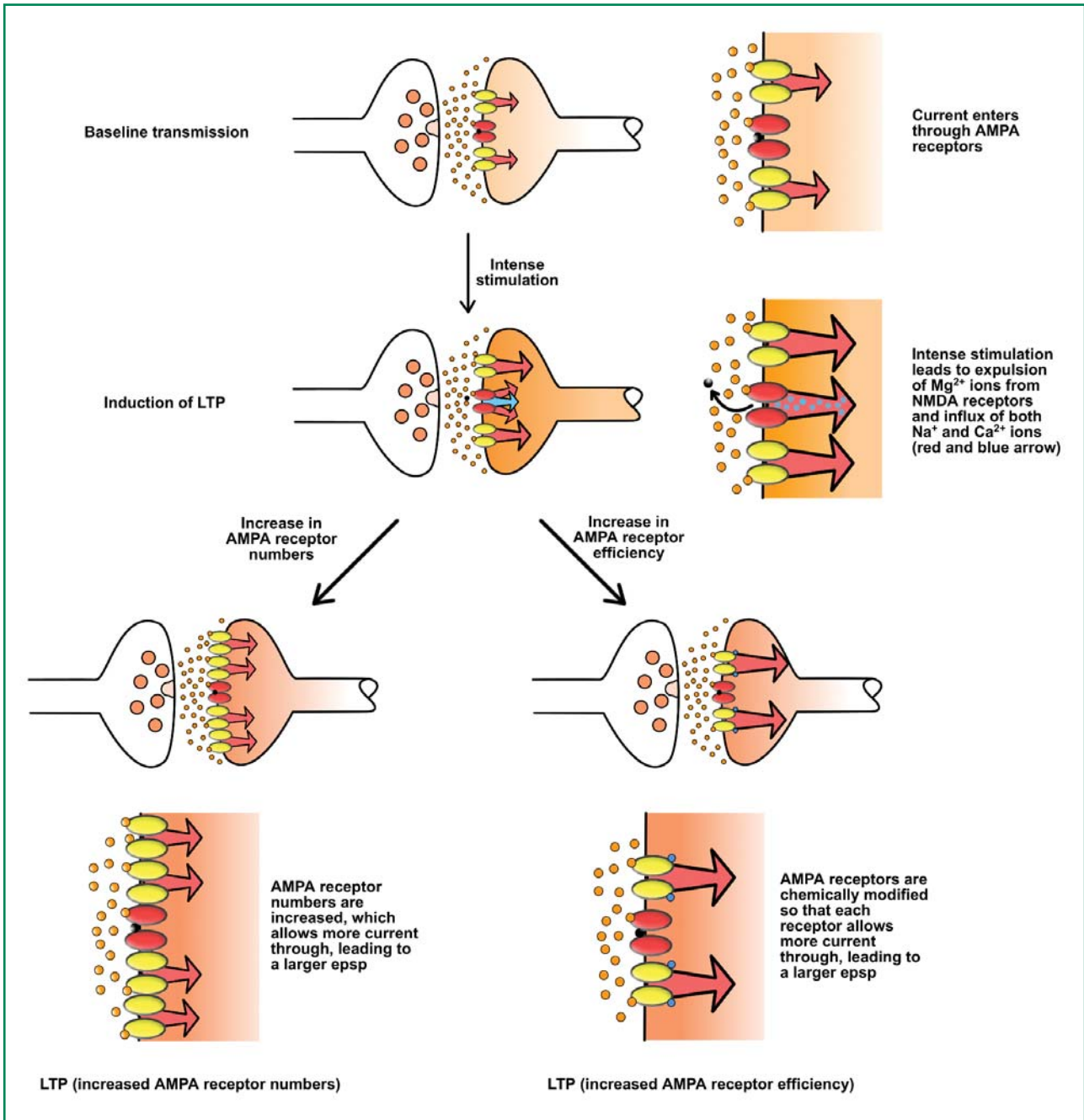

NMDA receptors (red) are the molecular machinery for learning. Transmitter is released during both baseline activity and the induction of LTP (top left). The site where Mg^{2+} (small black circle, top right) blocks the Ca^{2+} channel is inside the cell membrane and it is displaced by intense depolarization (next diagram down). This happens when neurons need to change their connectivity with other neurons. LTP can be expressed as either a larger number of AMPA receptors (yellow receptors, bottom left) or as more efficient AMPA receptors (bottom right).

NMDA receptors: molecular machines for triggering plasticity.

Glutamate also binds to NMDA receptors on the postsynaptic neuron. These are the critical molecular machines that trigger synaptic plasticity. If the synapse is activated quite slowly, the NMDA receptors play little or no role. This is because as soon as NMDA receptors open their ion channels these channels become plugged by another ion present in the synapse – magnesium (Mg^{2+}). But, when synapses are activated by several pulses very quickly to a set of inputs on to a neuron, the NMDA receptors immediately sense this excitement. This greater synaptic activity causes a large depolarisation in the postsynaptic neuron and this dispels the Mg^{2+} from the NMDA ion channels by a process of electrical repulsion. NMDA receptors are then immediately able to partake in the

synaptic communication. They do this in two ways: first, and just like AMPA receptors, they conduct Na^+ and K^+ which adds to the depolarisation; second, they allow calcium (Ca^{2+}) to enter the neuron. In other words, NMDA receptors sense strong neuronal activity and send a signal to the neuron in the form of a surge of Ca^{2+} . This Ca^{2+} surge is also brief, lasting for no more than about a second while glutamate is bound to NMDA receptors. However, Ca^{2+} is a crucial molecule as it also signals to the neuron when NMDA receptors have been activated.



Apparatus used for monitoring the tiny electrical voltages that occur at synapses.

Once inside the neuron, the Ca^{2+} binds to proteins located extremely close to the synapses where the NMDA receptors were activated. Many of these proteins are physically connected to the NMDA receptors in what constitutes a molecular machine. Some are enzymes that are activated by Ca^{2+} and this leads to chemical modifications of other proteins within or close to the synapse. These chemical modifications are the first stages of the formation of the memories.

AMPA receptors: our molecular machines for storing memories.

If NMDA receptor activation triggers plastic changes in the connectivity of neurons, what expresses the change in strength? It could be that more chemical transmitter is released. This can occur, but we are fairly certain that one set of mechanisms involves AMPA receptors on the post-synaptic side of the synapse. There are various ways of doing this. One way might be to enable AMPA receptors to work more efficiently, such as to pass more current into the neuron upon activation. A second way would be to enable more AMPA receptors to be inserted into the synapse. In both cases this leads to a larger *epsp* - the phenomenon of **LTP**. The opposite change, a reduction in the efficiency or number of AMPA receptors can result in **LTD**. The beauty of this mechanism for inducing LTP or LTD is its elegance yet relative simplicity - it can all occur within a single dendritic spine and thereby alter synaptic strength in a highly localised manner. It is the stuff that memories might actually be made of - an issue to which we return in the next chapter.

Exercising the brain

Changes in the functioning of AMPA receptors are not the whole story. As memories become more permanent, structural alterations occur in the brain. Synapses with more AMPA receptors inserted following the induction of LTP change their shape and may grow bigger, or new synapses may sprout out from the dendrite so that the job of one synapse can now be done by two. Conversely, synapses that lose AMPA receptors following the induction of LTD may wither and die. The physical substance of our brains is altering in response to brain activity. Brains like exercise - mental exercise of course! Just as our muscles grow stronger when we engage in physical exercise, so it now seems that our synaptic connections become more numerous and better organised when we use them a lot.

Mind over memory

How well we learn is greatly influenced by our emotional state - we tend to remember events associated with particularly happy, sad or painful experiences. We also learn better when we pay attention! These states of mind involve the release of neuromodulators, such as acetylcholine (during heightened attention), dopamine, noradrenaline and steroid hormones such as cortisol (during novelty, stress and anxiety). Modulators have multiple actions on neurons, several of which act via changes in the functioning of NMDA receptors. Other actions include the activation of special genes specifically associated with learning. The proteins that they make help to stabilise LTP and make it last longer.

The doctor within

Synaptic plasticity plays another critical function in our brains - it can help the brain recover from injury. For example, if the neurons that control particular movements are destroyed, as happens during a stroke or serious head injury, all is not necessarily lost. Under most circumstances, the neurons themselves do not grow back. Instead other neurons adapt and can sometimes take on similar functional roles to the lost neurons, forming another network that is similar. It is a process of re-learning and highlights certain recuperative abilities of the brain.

Jeffery Watkins
a medicinal chemist who transformed the
study of excitatory transmission in the
brain by developing drugs like AP5 (below)
that act on specific glutamate receptors.

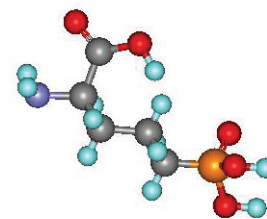

Learning & Memory

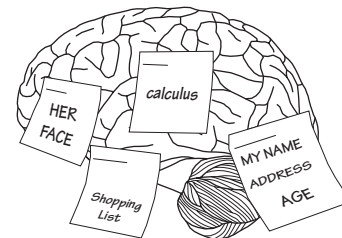

Memories are central to our individuality. What each of us remember is different from what others remember, even of situations we have been in together. Yet, in our distinct ways, all of us remember events, facts, emotional feelings and skills - some for a short time, others for a lifetime. The brain has multiple memory systems with different characteristics and mediated by different neuronal networks. The formation of new memories is now widely thought to depend on synaptic plasticity, as described in the last chapter, but we are still uncertain about the neural mechanisms of information retrieval. While we all complain about our memories, they are in the most part pretty good, only starting to fail in old age or certain neurological diseases. It might be good to try to improve our memory, but doing so could be at the cost of remembering many things that it is as well to forget.

of information very accurately. We use it to remember speech for long enough to interpret the flow of conversation, for doing mental arithmetic, and for remembering where and when we put our keys down a moment ago. Fidelity is central to the system - a feature that comes at the cost of limited capacity and persistence. It is often said that you can remember 7 ± 2 items in working memory; this is why so many telephone numbers are no longer than 7 or 8 digits. But remembering these accurately is essential. You can demonstrate the capacity and limited persistence of working memory in a simple experiment you can do with your friends.

The organisation of memory

There is no single brain area to which all the information we ever learn is shuttled for storage. **Working-memory** holds information in your mind for a short time in an active conscious state. The much larger, more passive storehouse of information is called **long-term memory**.

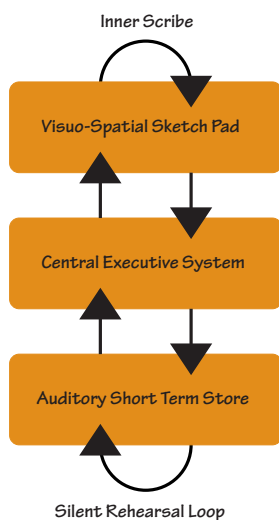

The short-term working-memory system of the brain

Working Memory

Like a pad on a desk for jotting down names or telephone numbers that we need to remember only briefly, the brain has a system for holding on to and working with small amounts

An Experiment on Short-Term Memory

A simple test of short-term or working memory is called "letter-span". You need a minimum of 2 people, although it works better with the whole class. Privately, one of you writes down a series of letters beginning with as few as 2, taking care they do not spell out a word (e.g. XT). This person then produces further letter strings, one letter longer at a time (e.g. a 5-letter string such as QVHKZ and a 10-letter string such as DWCUKQBPSZ). The experiment begins after these are prepared. The other person (or class) listens to each letter string in turn and, after about 5 seconds, tries to write down the letters in the correct order from memory. Starting with the easy 2-letter string, the memory test moves on to longer ones. Most people can do it perfectly up to about 7 or 8 letters - and then errors creep in. Very few can do 10 letters correctly. The capacity of short-term memory has been described as "the magical number 7 plus or minus 2".

A **central executive system** controls the flow of information, supported by two additional memory stores. There is a **phonological store** alongside a **silent rehearsal loop** - the bit of your brain that you use to say things to yourself. Even if you read words or numbers visually, the information will be transcribed into a phonological code and stored for a short while in this two-part system. There is also a **visual sketchpad** that can hold on to images of objects for long enough for you to manipulate them in your mind's eye.

Working memory is largely located in the **frontal and parietal lobes**. Brain imaging studies (see p. 41) using PET and fMRI brain imaging indicate that the auditory parts of working-

memory are generally lateralised to the left frontal and parietal lobes where they interact with neuronal networks involved in speech, planning and decision-making. These are activities for which a good working-memory is essential. The visual sketchpad is in the right hemisphere (see Box at end of chapter).

How did working-memory evolve? Animals, even most mammals, probably do not have quite the same sort of short-term memory system as we have, and it clearly didn't evolve to help early hominids remember telephone numbers! Studies with young children point to a critical role for working-memory in learning language, suggesting that this memory system may have co-evolved with speech. The precision required for keeping track of words and their order in a sentence is critical for accurately working out the correct meaning.

Long-term memory

Long-term memory is also sub-divided into different systems located in widely dispersed networks of the brain. The different networks do very different jobs. Broadly speaking, information enters sensory systems and then passes down pathways that provide increasingly specialised processing. For example, information entering the visual system passes down a so-called ventral pathway from the striate cortex to the medial temporal lobe through a cascade of networks that work out shape, colour, object identity, whether the object is familiar or not, until finally, some kind of memory is formed of this particular object and when and where it has been seen.

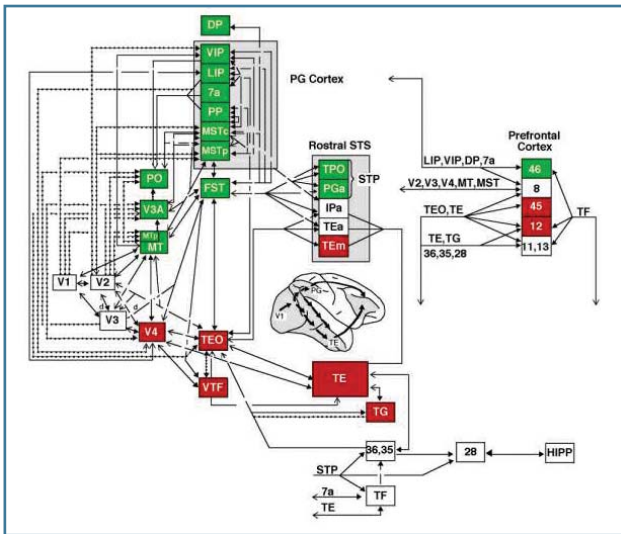

The cascade of brain areas through which visual information is first processed perceptually and then for the purpose of memory.

There are several ways of thinking about this cascade of analysis. First, there are areas in the cortex that extract a **perceptual representation** of what we are looking at. This is used to store and later recognise things around us. Our ability to identify familiar people in newspaper cartoons, such as politicians, reflects this system. Very closely related is a system called **semantic memory** - the vast storehouse of factual knowledge that we have all accumulated about the world. We know that Paris is the capital of France,

that DNA encodes genetic information as a sequence of base pairs, and so on. The critical property is that facts are organised into categories. This is vital for memory retrieval as the search process can then shuttle through tree diagrams in this storehouse to find things efficiently. If semantic memory were organised in the way that many people organise things in the attic of their houses - pretty randomly - we would have terrible trouble remembering anything. Fortunately, the brain sorts the information that we encode into categories, though it helps to have a skilled teacher for the complex things we learn at school. Indeed, gifted teachers build these structures in their pupils effortlessly.

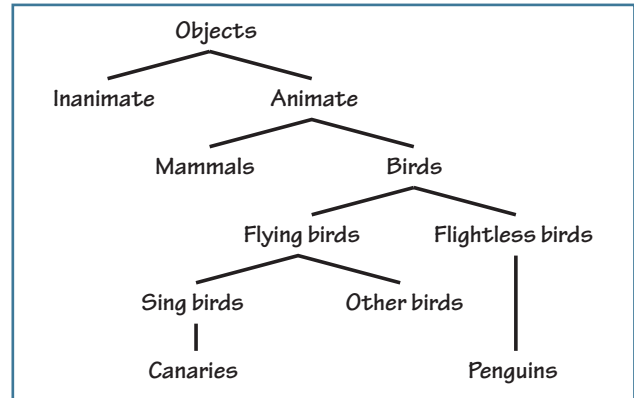

The facts we know about animals are organized in a tree-structure. We do not yet know how the networks of the brain do this.

We also learn **skills** and acquire **emotional feelings** about things. Knowing that a piano is a piano is one thing; being able to play it is another. Knowing how to ride a bicycle is useful, but being aware that certain situations on the road can be dangerous is no less important. Skills are learned through deliberate and extensive practice, whereas emotional learning tends to be much more rapid. Often it has to be fast, particularly for the things we learn to be afraid of. Both are types of learning called **conditioning**. Specialised brain areas are involved - the **basal ganglia** and **cerebellum** being very important for skill learning, and the **amygdala** for emotional learning. Many animals learn skills - it is very important for their survival.



Chimpanzees have learned the skill of fishing for termites using a stick. Young chimpanzees learn this by watching their parents.

Memory failure and the localisation of episodic memory in the brain

The last type of memory system in the brain is called **episodic** memory. It is what you use to keep track of personal experience. Remembering events is different from learning facts in one very important respect - events happen only once. If you forget what you ate at breakfast today (unlikely), or what happened last Christmas (possibly), or all the things that happened on your very first day at school (probably), you cannot re-run any of these events like an extra lesson in class. This system learns quickly because it has to.

We have learned a lot about what episodic memory is by studying neurological patients who, following a stroke, brain tumours or viral infections such as herpes encephalitis, sometimes have very specific deficits in this type of memory. Studying such patients carefully has been the major way to work out the anatomical organization of this and other memory systems.

“It is not so much the injury that captures our attention as how, through injury or disease, normal function is laid bare.”

(Sir Henry Head - 20th C Neurologist).

People affected by a condition known as **amnesia** cannot remember meeting other people only half an hour earlier. They cannot remember whether they have recently eaten a meal or ought to have one, and even such simple necessities of life as where things have recently been put down around the house. Shown a complex drawing - such as the one in the inset - they can copy it accurately but they cannot draw it as well as most of us could do from memory as little as 30 minutes later. Often, they cannot remember things that happened before they became ill. This is called **retrograde amnesia**.

Such a life lacks all structure in time and place and has been described by one extensively studied amnesic patient as like continually “waking from a dream”. Yet this same person

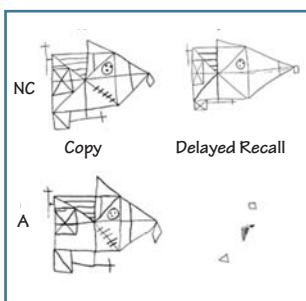

retains his command of language and the meaning of words, and enough working-memory to carry on a sensible conversation. It is not until one has exactly the same conversation with him a few minutes later that the devastating isolation of his existence is revealed.

Amnesics (A) can see just fine and copy complex drawings like this one quite accurately, but they cannot remember them for very long compared to normal control subjects (NC).

Amazingly, amnesic patients can learn some things that they cannot consciously remember! They can be taught motor skills or to read backwards very quickly.

Training to read backwards quickly takes a while. This is true for amnesics no less than for us, but whereas we would remember being taught to do this, they do not. This is a fascinating dissociation in their conscious awareness. Amnesics are certainly conscious when they learn, but are later unaware of having learned. They cannot recover conscious awareness from the past. The damage that causes this distressing condition can occur in a number of brain circuits. Areas of the midbrain called **mamillary bodies** and the **thalamus** seem to be critical for normal memory, as is a structure in the medial temporal lobe called the **hippocampus**. Damage in these regions seems particularly to affect the formation of episodic and semantic memories.

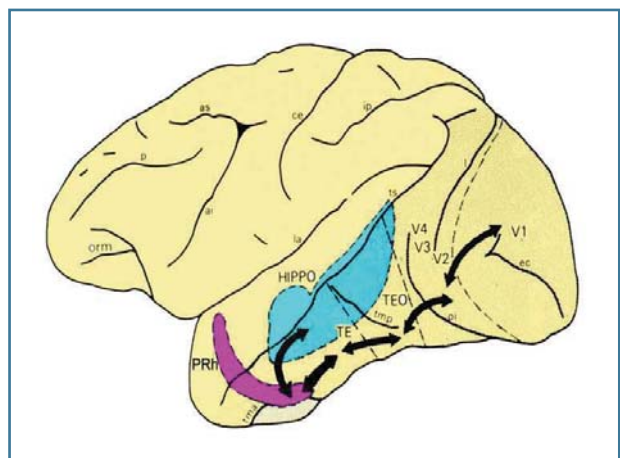

Two structures are very important for episodic memory - the perirhinal cortex (PRH) which mediates the sense of familiarity about the past and the hippocampus (HIPPO) which encodes events and places.

Other memory systems

Damage elsewhere in the brain affects other memory systems. Degenerative conditions, such as certain types of **semantic dementia** (a type of Alzheimer's Disease), can cause fascinating patterns of breakdown of semantic memory. Early on, patients will be quite capable of telling you that the pictures they are being shown in an experiment are of a cat, or a dog, or of a car, or a train. Later on in the disease, they may hesitate to call a picture of a mouse a mouse, saying instead that it is a dog. What this confirms is that factual information is organised categorically, with animate information stored together in one place well away from inanimate information.

The neurobiology of memory

Studying neurological patients carefully helps us to discover where memory functions are in the brain, but finding out how they work in terms of neurons and chemical transmitters involves carefully conducted research using laboratory animals.

Neuroscientists now believe that many aspects of the fine-tuning of neural connections in the developing brain are also used during early learning. The attachment that develops between an infant and its mother has been studied in young chicks in a process called **imprinting**. We now know

where this learning process takes place in the young chick's brain and the chemical transmitters that are released to act on receptors involved in storing some kind of an 'image' of the mother. This image is quite precise, such that the young chick will follow its mother but not another. Young animals also need to know what foods are safe to eat by tasting small amounts of food at a time, and learning those that taste bad. This cannot be left to genetic predispositions alone - developmentally tuned learning mechanisms are at work. Downstream of the receptors activated during imprinting or the tasting of food, a cascade of second-messenger chemicals transmit signals to the nucleus of brain cells where genes are activated to make special proteins that can literally fix the memory.

Place cells are another important discovery. These are neurons in the hippocampus that fire action-potentials only when an animal explores a familiar place. Different cells code for different parts of the environment such that a population of cells is involved in mapping a whole area. Other cells in a nearby brain area code for the direction the animal is moving in. The two areas working together - the map of space and the sense of direction - help the animal learn to find its way around the world. This is clearly very important for animals, because finding food and water and then their way back to the burrow, nest, or other home is vital for their survival. This navigational learning system relates to both semantic and episodic memory. Animals form a stable representation of where things are in their territory - just like the factual knowledge we acquire about our world. And this map of space provides a memory framework in which to remember events - such as where a predator was last seen. Place cells may code more than just place - they may help animals to remember where events have happened.

The Hippocampus

This Golgi stain shows a subset of neurons in black

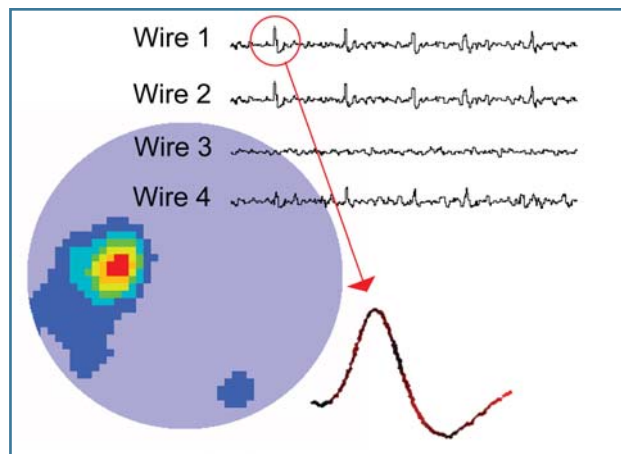
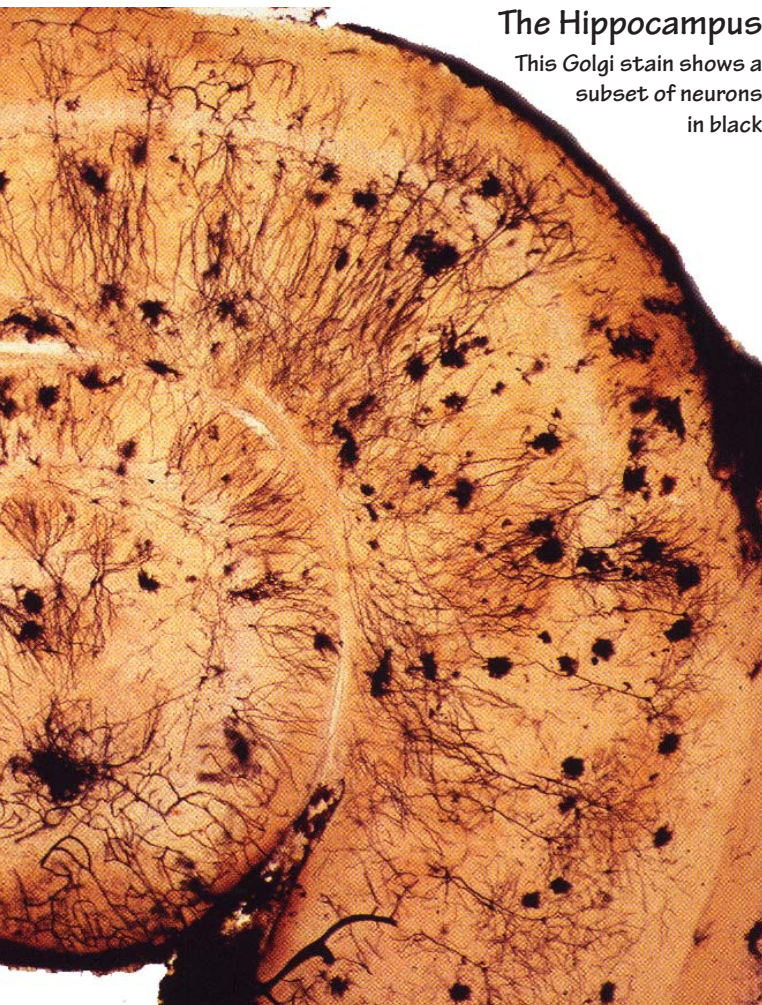

Four recording wires near cells in the hippocampus reveal nerve impulses on two of the wires (1 and 2, occasionally 4) that represent neurons firing at a particular place (red hot spot in the circular enclosure). Expanding the time scale (red circle) shows the shape of the spikes in the brain.

How are these maps and other memory traces formed? One emerging view is that synaptic plasticity based on NMDA receptors is involved. In the last chapter, we described how activating synaptic plasticity changes the strength of the connections in a network of neurons and that this is a way of storing information. Learning about places is impaired when a drug that blocks **NMDA receptors**

is applied to the hippocampus. For example, rats and mice can be trained to swim in a pool of water to find an escape platform hidden at one place underneath the water surface. They use their place cells and head-direction cells to help find their way, and they encode the correct location of the platform into memory using plasticity triggered by NMDA receptors. Also gene knockout animals have been engineered in which NMDA receptors have been deleted in the hippocampus. These animals are also bad at learning and they also have very inaccurate place cells. In the last chapter, we explained that changes in synaptic weights are expressed through alterations in excitatory AMPA receptors. We still don't know if that is true of memory - it is a topic of intense research just now.

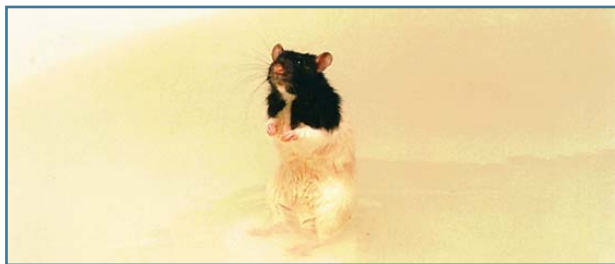

The rat has swum in the pool to the hidden platform on which it is standing.

Can we improve memory?

We all think that it would be good to improve the capacity or persistence of our memory. Older people often complain about their memory. However, improving memory would almost certainly come at a price. This is because a good memory is a balance between remembering and forgetting. If we were to improve it, we might then have difficulty forgetting all the trivial things that happened during the day that there is no need to remember. The 'yin and yang' of a good memory is one that remembers and organises the right things in the brain, but forgets things that seem less important. It seems unlikely that we shall ever have a pill that will act like a magic bullet to improve memory, at least in normal people. Evolution has ensured that the system is optimally balanced.

Having said that, really serious forgetfulness might be alleviated by drugs that make NMDA or AMPA receptors work better, or drugs to stimulate the cascade of second-messenger signals that studies of learning in young animals have identified. It would be helpful also to find some way of stemming the course of neurodegenerative diseases such as Alzheimer's Disease that affect memory early on. One of the exciting adventures in neuroscience today, for scientists in universities, research institutes and pharmaceutical companies, is working on projects of this kind. With the population demography of virtually all developed countries veering towards a greater preponderance of older people, treatments that could help them lead independent lives for longer would be greatly valued.

However, some scientists believe that **cognitive engineering** will be needed alongside drugs. You do not hear so much about cognitive engineering in the newspapers as about new

Research Frontiers

Taxi drivers imagining a route show increased activity in and near the hippocampus

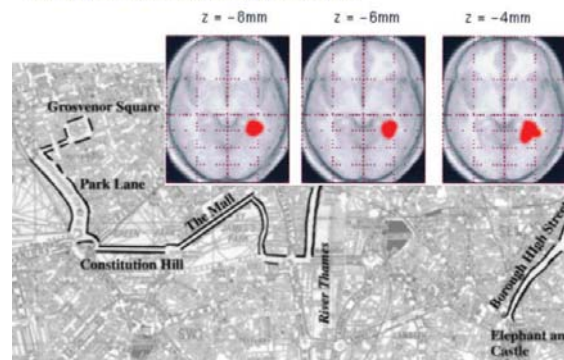

London taxi drivers have to know the city very well before they are allowed to ply the city for fares. When researchers put experienced taxi drivers in a brain scanner and asked them to imagine a trip from Marble Arch to Elephant and Castle, they saw greater activation in the right parahippocampal cortex (red areas). Structural MRI scans of taxi drivers show changes in the relative size of different parts of their hippocampus that may be related to how much of the city they are able to remember - although there could be other factors as well.

drugs, but it is no less important. The idea is to take advantage of what has been learned about how information is encoded, stored, consolidated (the 'fixing' process) and then retrieved. Paying attention, spacing out learning sessions, and getting frequent reminders to help the 'fixing' process are all examples. Some elderly patients with memory problems are finding a paging system called "NeuroPage" quite helpful - it reminds them of what they should be doing next and so helps them structure their day in a manner that they might otherwise forget to do. Recognising the different operating principles of episodic memory and skill learning is also essential - you will never learn a skill by merely hearing about it, although this works fine for episodic memory. Anyone trying to learn a skill must practice often, as the pupils of any music teacher are always reminded.

Alan Baddeley
who developed the idea of working memory, which consists of a number of different interacting systems.



The phonological store, visuospatial sketch pad and central executive are located in various parts of the brain.

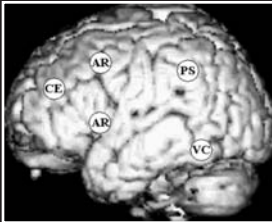
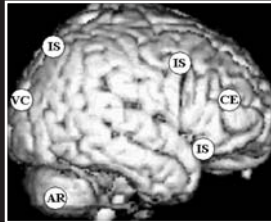

Stress

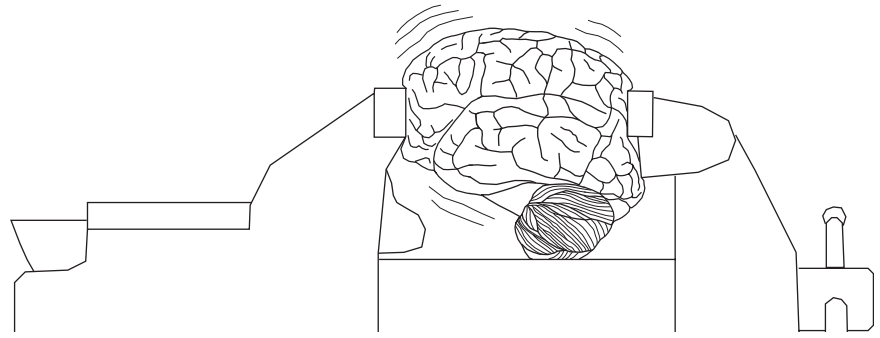

Stress affects even the most seemingly tranquil lives. We all experience it - during exams, competing in sports, or when falling out with friends and enemies alike. Why does it occur and what causes its unpleasant sensations? Is it good for anything? What happens when it goes wrong? Neuroscientists are beginning to understand how the brain generates a coordinated chemical response to stress.

What is stress and why do we need it?

Stress is tricky to pin down. It isn't just being under pressure - for this is not always stressful - but some kind of mismatch between what the body and brain anticipate and what challenges we actually experience or feel. Many challenges that we face are **psychological** - reflecting the difficulties of interacting with others as we work towards academic success, compete for a place in the school team or, later in life, for a job. Other stresses are **physical** such as an acute illness or a broken leg in a car accident. Most stressors are mixed: the pain and other physical afflictions of an illness are coupled with worry and concern.

Stress is a fundamental process. It affects all organisms, from the simplest bacterium and protozoan, to complex eukaryotes such as mammals. In single-celled organisms and in the individual cells of our bodies, molecules have evolved which provide a series of emergency systems that protect key cellular functions from unexpected external challenges and their internal consequences. For example, special molecules called **heat-shock proteins** guide damaged proteins to where they can be repaired or harmlessly degraded, thus protecting cells from toxicity or dysfunction. In complex organisms such as ourselves, stress systems have evolved as highly sophisticated processes to help deal with out-of-the-ordinary challenges that may afflict us. These use the cellular protection mechanisms as building blocks in a larger network of stress protection.

Stress and the brain

Stress is perceived and the response co-ordinated by the brain. Our cognitive appraisal of a situation in the brain interacts with bodily signals in the blood stream such as hormones, nutrients, and inflammatory molecules, and with information from peripheral nerves monitoring vital organs and sensations. The brain integrates these to produce a series of specific and graded responses. Our understanding of how it does this has come from the study of **neuroendocrinology**. Circulating hormones in the blood are monitored by the brain to enable the body to cope with stress.

Fight or Flight?

The easiest response to recognise is the immediate activation of what is - endearingly - called the **sympathetic nervous system**. After receiving a stressful challenge and computing the right response, the brain rapidly activates nerves originating from control centres in the brainstem. These cause the release of noradrenaline in a variety of structures and of adrenaline from the adrenal glands (situated just above the kidney). Their release underpins the **fight or flight** response - the classical, immediate reaction that has to be made in response to danger. We all recognise the **initial tingling sensation, sweating, heightened awareness, rapid pulse rate, higher blood pressure** and **general feelings of fear** that we all feel in the moments immediately after a stressful challenge. These changes happen because of receptors that are found on blood vessels, causing them to constrict and so our blood pressure to shoot up, and in the heart, causing it to accelerate and produce the pounding sensation in the chest known as palpitations. There are also receptors in the skin causing hairs to erect (goosebumps) and in the gut causing those disconcerting abdominal sensations that we all sense as stress. These changes are there to prepare us to fight or to flee - and to concentrate blood flow to vital organs, the muscles and the brain.

The hypothalamic-pituitary-adrenal (HPA) axis

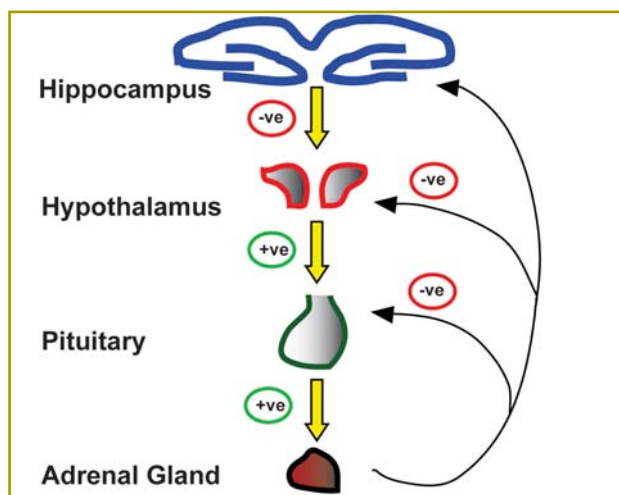

The HPA Axis. The hypothalamus at the centre controls the release of hormones from the pituitary that act on the adrenal glands. Negative feedback of the hormonal release is provided at various levels of the axis.

The second major neuroendocrine response to stress is activation of a circuit linking the body and brain called the **HPA axis**. This links together the **hypothalamus, pituitary gland, adrenal cortex** and **hippocampus** by a bloodstream highway carrying specialised hormones.

The hypothalamus is the key brain area regulating many of our hormones. It has strong inputs from areas of the brain processing emotional information, including the amygdala, and from regions of the brainstem controlling sympathetic nervous responses. It integrates these to produce a co-ordinated hormonal output that stimulates the next part of the circuit - the pituitary gland. In turn, this releases a hormone called adrenocorticotrophin (**ACTH**) into the blood. ACTH then stimulates a part of the adrenal gland to secrete cortisol.

Cortisol is a steroid hormone that is the key to understanding the next phase of the stress response. It raises blood sugar and other metabolic fuels such as fatty acids. This often occurs at the expense of proteins that are broken down into fuels required immediately - instant 'chocolate bars' for the muscles and brain. Cortisol also helps adrenaline to raise blood pressure and, in the short term, makes you feel good. Faced with the challenge of singing a solo at the school concert, the last thing you want to do is dwell on worrying things. You just want to do it right with as little self-consciousness as possible. Cortisol also turns off growth, digestion, inflammation, and even wound-healing - clearly things that can be better done later on. It also turns off sex. The last step of the circuit is **cortisol feedback to the brain**. The highest density of cortisol receptors is in the hippocampus, a key structure for learning and memory, but cortisol also acts on the amygdala, which processes fear and anxiety. The net effect is to turn on the amygdala - to allow learning of fear-related information; and to turn off the hippocampus - to ensure that resources are not wasted on more complex but unnecessary aspects of learning. Cortisol is focus juice.

STRESS IS INEVITABLE, SOMETHING WE ALL EXPERIENCE. IT MAY BE PSYCHOLOGICAL, PHYSICAL OR (USUALLY) BOTH.

A tale of two cortisol receptors and the shrinking hippocampus

The hippocampus has high levels of the two receptors for cortisol - let's call them the **low MR** and the **high GR** receptor. The low MR receptor is activated by the normally circulating levels of cortisol in the bloodstream highway of the HPA axis. This keeps our general metabolism and brain processing ticking over nicely. However, as cortisol levels begin to rise, particularly in the morning, the high GR receptor becomes progressively more occupied. When we become stressed, cortisol levels become very high indeed, activation of this receptor is sustained and the hippocampus is then shut down by a genetically controlled program. Put all this together and you have what is called a **bell-shaped curve**. This is the classical curve relating stress to brain function - a little bit is good for you, a bit more is better, but too much is bad!

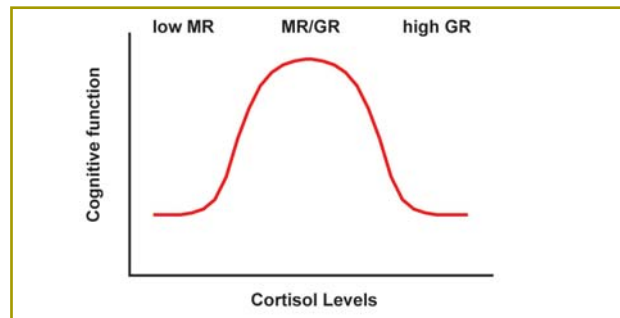

The bell-shaped curve for stress. A little bit of stress can make things better, but too much makes things worse.

Depression and stress-system overactivity

An excess of cortisol in the blood is seen in some chronic brain diseases. In particular, in **severe depression** cortisol is over-produced and recent work suggests that the hippocampus also shrinks in this condition. Such findings have led psychiatrists to think of severe depression as severe long-term stress. It is not at all certain that the increased cortisol is the primary cause of this illness rather than it being simply a consequence of severe psychological upset and its attendant stress. However, patients can be markedly helped by blocking the production or action of cortisol, particularly those in whom classical anti-depressant drug treatments do not work. Anti-depressant drugs often help to normalise the overactive HPA axis. One idea is that they do so, in part, by adjusting the density of MR and GR receptors in the brain, particularly in the hippocampus. Neuroscientists working on this hope to develop more effective treatments for stress disorders that work by resetting the feedback control system and reducing excessive hormonal stress responses.

Stress and ageing

Ageing of the brain is accompanied by a general decline in function, but a decline that varies a great deal between individuals. Some individuals maintain good cognitive abilities with age (successful ageing), whilst others do not do so well (unsuccessful ageing). Can we get a molecular understanding of this? Cortisol levels are higher in unsuccessful than in successful ageing. This rise precedes the fall in mental abilities and the associated decline in the size of the hippocampus seen in brain scans. Experiments in rats and mice have shown that keeping stress hormone levels low from birth, or even from middle age onwards, prevents the emergence of memory defects otherwise seen in untreated populations. So it appears that individuals with excessive hormone responses to stress - not necessarily those who had most stress, but those who make the greatest responses to stressors - are those who get more memory loss and other cognitive disorders with advancing years. If this is true in humans as well, we may be able to reduce the burden of such effects, perhaps by exploiting antidepressant drugs that keep the HPA stress system under control. Stress is a major feature of modern life - and there is more to the story. But to describe this, we will have to bring in the immune system.



The Immune System

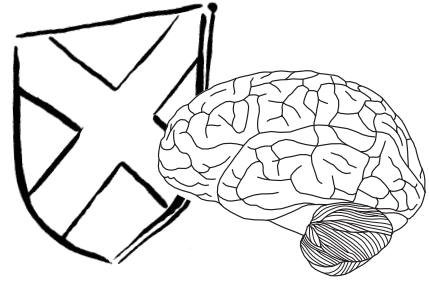

Until just a few years ago, the brain was thought to be an “immune privileged organ” because it was not affected by immune responses or inflammation. It is certainly protected to some extent from external events by the “blood brain barrier”. This is not really a barrier, but specialised endothelial cells in the brain blood vessels that are relatively resistant to the passage of large molecules or immune cells from the blood into the brain. However, this view of the brain as privileged has changed dramatically over the last decade as the result of research on brain-immune system interactions. Neuroimmunology is now a very active area of research.

Body defences

The **immune system** is our first line of defence against malicious invaders. These invaders, viruses, bacteria and yeast, range from common and mild, such as the all too familiar cold, to severe and life threatening, e.g. HIV, meningitis or tuberculosis.

Our defences work in many ways. The first is locally within the tissue that is infected, injured or inflamed, causing swelling, pain, changes in blood flow and release of local inflammatory molecules. More generally, activation of the

immune system triggers cells called **leucocytes** and **macrophages**, and **acute phase proteins** that travel to the site of attack, to identify, kill and then remove invading pathogens. In addition, the acute phase response generates the symptoms we have all felt (fever, aches and pains, sleepiness, loss of appetite, disinterest). Each of these responses helps to combat infection, conserve energy and aid repair, but when activated too much or for too long they can be very damaging. So they need to be carefully controlled.

The brain and defence responses

The view of the brain an immunologically privileged organ has now given way to a very different conception of its relationship to the immune system. This is because it is now known that the brain can, and does, respond to signals from the immune system and from damaged tissues. The old orthodoxy has been overthrown. Experiments have revealed that the brain exhibits an array of local immune and inflammatory responses, and indeed is an important controller of the immune system and of the acute phase response. Many responses to disease, such as fever (body temperature), sleep, and appetite, are regulated primarily by the hypothalamus.

The brain receives signals from injured or infected tissues that may be neural in origin (via sensory nerves) or humoral (via circulating molecules). Neural signals seem to be via C-fibres (which also communicate pain – see Chapter 5) and via the vagus nerve from the liver – a key site for production of acute phase proteins. The nature of the main circulating signals to the brain are not fully understood, but are believed to include **prostaglandins** (which are inhibited by aspirin), and **complement proteins** (a cascade of proteins important in killing invader cells). But perhaps the most important signals are a group of proteins which came to light only in the last 20 years – known as **cytokines**.

Cytokines as defence molecules

Cytokines are the body’s retaliators. There are now well over 100 of them - and more are being discovered all the time. These proteins are normally produced in the body at very low levels, but are switched on quickly in response to disease or injury. They include **interferons**, **interleukins**, **tumour necrosis factors** and **chemokines**. Many are produced locally within damaged tissues and act on cells nearby, but some enter the blood stream where they send signals to distant organs including the brain. It is cytokines that cause most of the responses to disease and infection.

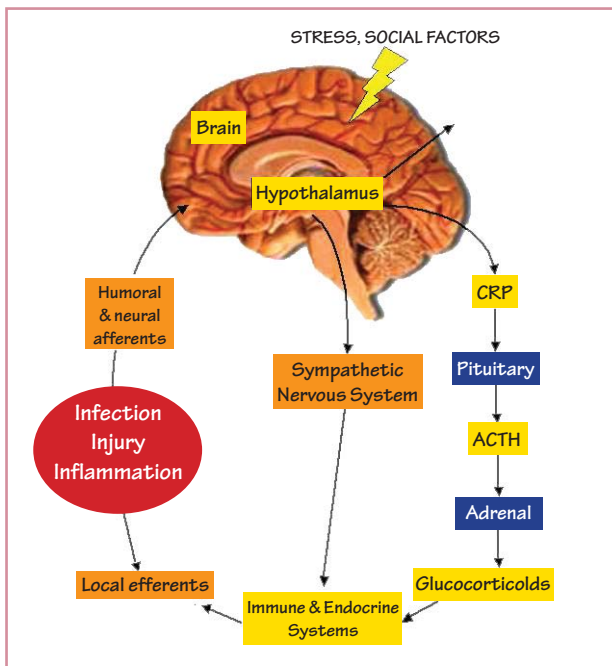

Many brain mechanisms come together to coordinate the brain and the immune system.

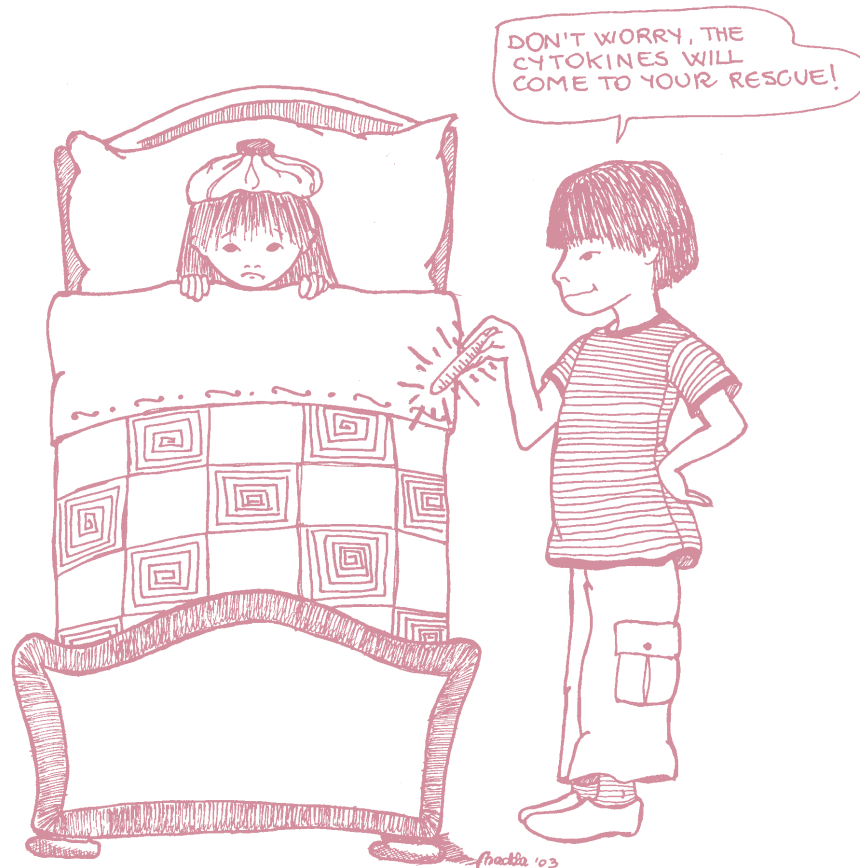

The triggers for cytokine production include bacterial or viral products, damage to cells or threats to cell survival such as toxins or low levels of oxygen. Another important regulator of cytokine production is the brain that, through neural signals to tissues (mainly via the sympathetic nervous system) or hormones (such as cortisol from the adrenal gland), can switch cytokines on or off.

Cytokines are protein molecules with many actions, particularly on the immune system. Most stimulate the immune system and the key components of inflammation such as swelling, local changes in blood flow, and the release of a second wave of inflammatory molecules. They act on almost all physiological systems, including the liver where they stimulate the acute phase proteins. However, although cytokines share many actions, they also vary significantly. Some are anti-inflammatory and inhibit pro-inflammatory process; most act locally on cells close to where they are produced, while others are released into the circulation, like hormones.

Stress and immune system

We have all heard that stress and worry can lower our defences and can make us ill. We are now starting to understand not only how stress can affect the brain directly by activating the HPA axis (described in the previous chapter), but also how it can influence the immune system – not surprisingly by an indirect route that is also through the brain. Stress can influence the immune system and susceptibility to disease, but it depends on the type of stress and how we respond – some people clearly thrive on it. It is the sorts of stress that we cannot cope with that can

inhibit our defence responses, such as excessive work or major tragedies. The precise mechanisms responsible for the link between stress and the immune system are not fully worked out, but we do know that an important feature is activation of the **hypothalamic-pituitary-adrenal axis**. One of the main responses to stress in the brain is increased production of a protein in the hypothalamus called **corticotrophin releasing factor (CRF)**. CRF travels the short distance from the hypothalamus to the pituitary gland to release another hormone, **adrenocortrophin releasing factor (ACTH)**. This hormone travels via the circulation to the adrenal gland to release steroid hormones (**cortisol** in humans), which are some of the most potent suppressors of immune function and inflammation. But the story seems to be more complex than this because there are other hormonal and neural elements, and we also know that some forms of mild stress can actively improve our immune function.

Immune and inflammatory responses within the brain

Recent research has shown that many of the defence molecules such as cytokines are also active contributors to brain diseases such as multiple sclerosis, stroke and Alzheimer's. It seems that over production of such molecules within the brain itself can damage neurons – particularly certain cytokines. Various new treatment strategies for brain disease are now being developed with the idea of inhibiting immune and inflammatory molecules. So neuroimmunology – a newcomer to the field of neuroscience may provide some clues and possible treatments for major brain diseases.



Sleep

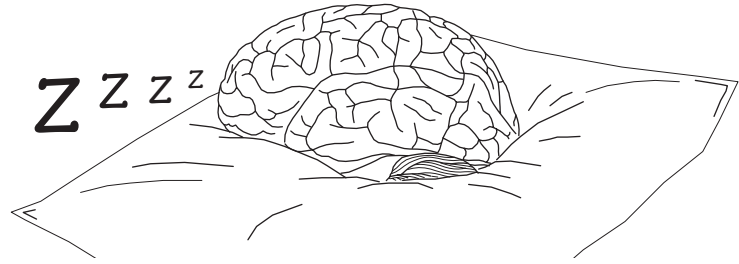

Every night we retire to our bedroom, climb into bed, and drift off into the unconscious state of sleep. Most of us sleep for about 8 hours, which means we spend roughly a third of our lives unconscious - part of it dreaming. If you try to avoid sleep to use this precious time for other activities, such as late night parties or burning the midnight oil cramming for exams, your body and brain will soon tell you that you shouldn't. We can stave it off for a while but never for long. The sleep/wake cycle is one of a number of rhythmical activities of the body and brain. Why do they exist, what parts of the brain are involved and how do they work?

A rhythm to life

The **sleep-wake cycle** is an endogenous rhythm that gradually becomes locked to the day-night cycle through the first years of life. It is what is called a **circadian rhythm** - so called because 'circa' is Latin for around, and 'dies' for day. It is important throughout life: babies sleep for short periods during both the day and the night, young children often take a nap after lunch, while adults generally sleep only at night. Sleep is good for you - Winston Churchill, the Prime Minister during World War II, was said to be partial to short naps of five minutes or so - sometimes during cabinet meetings!

The normal pattern locking in sleep and wakefulness to the day-night cycle is partly controlled by a small group of cells in the hypothalamus just above the optic chiasm called the **suprachiasmatic nucleus**. The neurons here, which are unusual in having lots of synapses between their dendrites to synchronise their firing together, are part of the brain's biological clock. In humans, it ticks away at a rate just a bit slower than a day, but is normally kept in register by inputs from the eye telling it when it is day-time or night-time. We know this because people who have participated in sleep experiments by living in deep caves for long periods of time, away from all clues as to the true time of day, adopt patterns of activity that **free-run** to a sleep-waking cycle of about 25 hours.

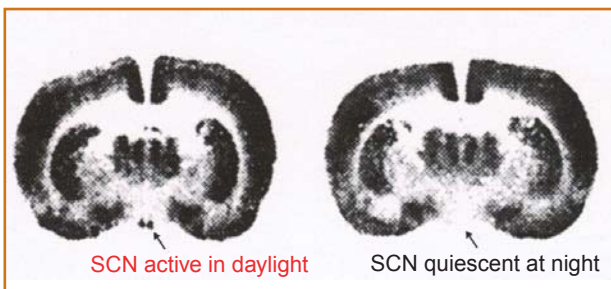

SCN active in daylight

SCN quiescent at night

The suprachiasmatic nucleus is the brain's own personal clock.

The stages of sleep

Sleep is not quite the passive process it seems. If a person is wired up with electrodes to their scalp in a sleep laboratory (which has beds not benches!), the brain's electroencephalogram (EEG) passes through several discrete stages. When awake, our brains show low-amplitude electrical activity. As we fall asleep, the EEG becomes flatter at first but then, gradually, it shows increases in amplitude and decreases in frequency as we move through a series of discrete stages of sleep. These stages are called **slow-wave sleep (SWS)**. The reasons for these changes in electrical activity are still not fully understood. However, it is believed that as neurons in the brain become unresponsive to their normal inputs, they gradually become synchronised with each other. You lose muscle tone as the neurons controlling skeletal muscle movements are actively inhibited but, thankfully, the ones controlling respiration and heart rate carry on working normally!

Throughout the night, we cycle back and forth between these different stages of sleep. In one of them, the EEG becomes like the waking state again and our eyes jerk back and forth beneath our closed eyelids. This is the so-called **rapid eye movement (REM)** stage of sleep when we are more likely to dream. If people are woken during REM sleep, they almost invariably report dreaming - even those who habitually claim that they never dream (try it as an experiment on a member of your family!). In fact, most of us will have about 4 to 6 short episodes of REM sleep each night. Babies have a bit more REM sleep and even animals show REM sleep.

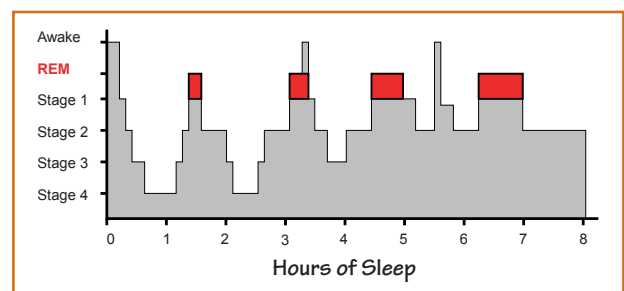

A normal night's sleep of 8 hours consists of a pattern of different sleep stages, with short bursts of REM sleep (red areas) occurring about 4 times each night

Sleep Deprivation

Some years ago, an American teenager called Randy Gardner resolved to try and win his place in the Guinness book of Records by going without sleep for the longest period ever recorded. His ambition was to last 264 hours without sleep - and he did it! It was a carefully controlled experiment

supervised by doctors in the American Navy - not one we recommend you repeat! Amazingly, he survived very well. The main difficulties he had (apart from feeling very sleepy) were difficulties with speech, an inability to concentrate, lapses of memory and hallucinatory daydreaming. But his body remained in excellent physical condition and he never became psychotic or lost contact with reality. After the experiment was over, he showed a small rebound, sleeping for nearly fifteen hours the first night and short extra periods on succeeding nights. This and many other similar experiments have convinced sleep researchers that it is primarily the brain and not the body that really gains from sleep. Similar conclusions have come from other studies, including carefully controlled animal experiments.

Why do we sleep?

Many issues in neuroscience remain an enigma and sleep is one of them. Some people have argued that sleep is just a convenient way for animals to be kept immobile and so out of danger. But there must be more to it than that. The sleep deprivation experiments lead us to think that REM sleep and certain phases of SWS enable the brain to recover. We have this kind of sleep during the first 4 hours of the night. Perhaps it helps to reset things in the brain and that a good time to do this necessary task is, by analogy with a ship in dry dock, when the brain is not processing sensory information, or being vigilant and attentive, or having to control our actions. Research also suggests that sleep is the time when we consolidate what we have learned the day before - an essential process in memory.

How do rhythms work?

A great deal has been learned about the neural mechanisms of rhythmical activities such as sleep by recording the activity of neurons in various brain areas during the transitions between different sleep stages. These have revealed a brain-stem activating system involving various neuromodulatory transmitters, including one called

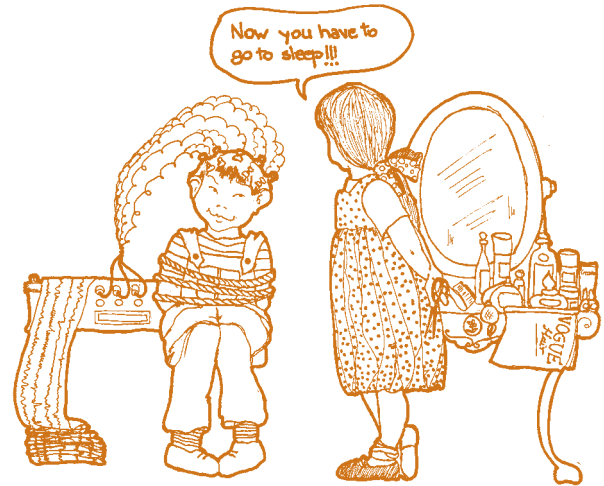

adenosine, in a kind of **molecular chain reaction** that takes us through the various sleep stages. Synchronisation mechanisms enable networks to pass from one sleep state to another.

A big leap forward has come from neurogenetics. Various genes have been identified that, like the cog-wheels and escapement of a clock, are the molecular components of rhythmical pacemakers. Much of this work has been done in **Drosophila** (fruit flies) where it has been found that two genes - **per** and **tim** - produce proteins that interact together to regulate their own synthesis. mRNA and protein synthesis begins early in the day, the proteins accumulate, link up together and this linkage then stops their own synthesis. Daylight helps to degrade the proteins whose level eventually drops to a point where the genes that make PER and TIM protein get going again. This cycle goes round and round, and will even carry on if the neurons are kept alive in a dish. The clock in mammals such as ourselves operates in a remarkably similar way to the one in flies. As circadian rhythms are very old in evolutionary terms, it is perhaps no surprise that the same types of molecules drive the clock in such different organisms.

Research Frontiers

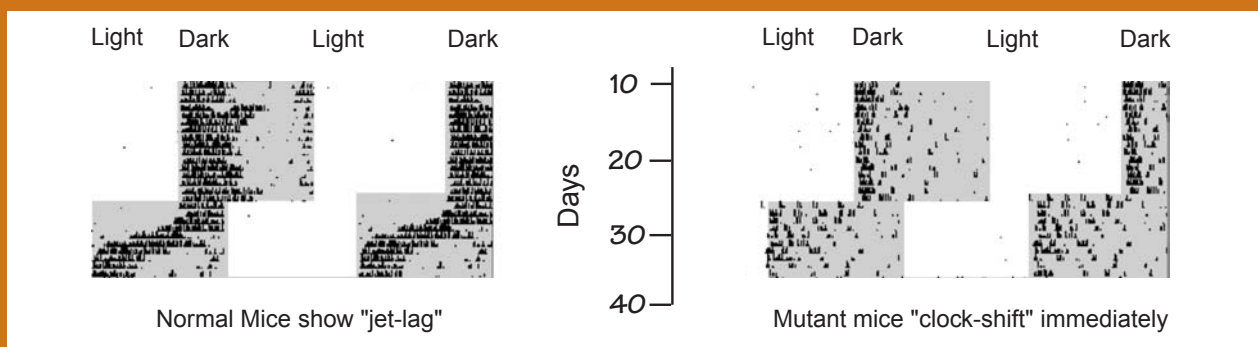

Mice who don't show jet-lag!

To try to understand the molecular mechanisms of circadian rhythms better, neuroscientists have genetically engineered mice in which genes expressed in the suprachiasmatic nucleus are "knocked out". These VIPR2 mice live fine and show changes in activity patterns between night and day just like normal mice. The black dots of the pattern above show when the mice are active - a daily rhythm with activity at night (grey areas). However, when the time that the lights are turned out is suddenly shifted forward by 8 hr (around day 25), normal mice show "jet-lag" by taking a few days to shift their activity patterns. The knock-out mice shift immediately. These kinds of studies should help us learn about the molecular mechanisms by which light entrains circadian pacemaker genes.



Brain Imaging

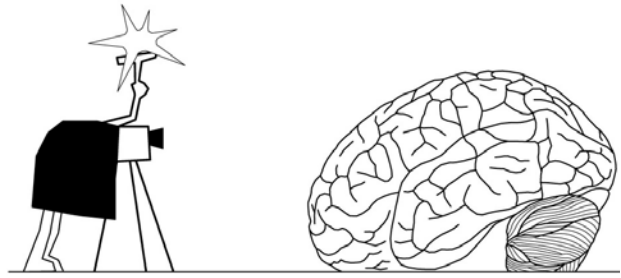

Phrenologists thought they could understand the brain by examining the bumps on the surface of the skull. If this seems far-fetched now, their ambition to understand the brain by looking at it from outside the skull has fascinated many throughout the ages. Now we really can do this – through the advent of modern brain imaging techniques. Modern scanners use a variety of means to give us wonderful images of neuronal and fibre pathway structure, of blood flow and energy metabolism in the brain, and of the changes in neural activity that occur when we do different things.

The walkway to modern techniques

In attempts to relate structure to function, a great deal has been learned by neurologists and neuropsychologists who correlate any oddities of mind or behaviour with measurements of brain structure at postmortem. It was in this way that the speech areas of the brain were identified by Broca. This approach has had many successes, but it also has limitations. One cannot make the simple assumption that the loss of a function due to damage to a region of the brain represents the normal function of that region. For instance, a deficit might occur because that region is cut-off or disconnected from other regions with which it normally communicates. It is also possible that brain areas that are undamaged may take over some functions that are performed by the damaged area under normal circumstances; this is known as plasticity. Finally, very few pathological lesions are confined to a precise functional area. And there may be long delay between the study of a patient when they are alive and the later analysis of their brain.

Structural brain imaging techniques began to be developed about 30 years ago. The recent development of functional imaging methods by medical physicists has attracted particular attention. These enable us – literally – to see inside the skull and so peer into the human brain – as it thinks, learns or dreams.



Left: The profits made by E.M.I. from the sale of records by 'The Beatles' helped to pay for the development of the first brain scanners. These and later machines have enabled neuroscientists to look into the brain in new ways. Right: A modern MRI scanner. The subject lies on a table that is moved into the ring of magnets for the scan that may take anything from 30 min to 1 hour.

How it all works

Electrophysiological techniques for monitoring neuronal activity are based on changes in the membrane potential of activated neurons. Brain scanning techniques work by monitoring changes in energy metabolism required by activate neurons.

The electrochemical gradients that move charged ions in and out of neurons (that underlie synaptic and action potentials) require energy for their operation. The source of this energy is oxidation of glucose. Glucose and oxygen are delivered to the brain by the cerebral circulation. By virtue of the **neurovascular link**, there is a local increase in cerebral blood flow in active areas. This occurs very quickly. Modern neuroimaging devices measure these changes in local cerebral blood flow and use them as an index of neural activity.

The first functional technique to be developed was called **Positron Emission Tomography (PET)**. This procedure involves the injection, into the humansubjects, of radioactive tracers that are attached to compounds of biological interest (such as drugs that bind to neurotransmitter receptors). Rings of detectors around the subject's head record the timing and position of gamma particles emitted by the nuclear isotope as it traverses the brain and decays. PET can be used to produce maps of changes in local cerebral blood flow (CBF). Such measurements have led to the localisation in the human brain of sensory, motor and cognitive brain functions. There are several disadvantages of PET, the major one being that it requires the injection of radioactive tracers. This means that many people cannot have a PET scan, such as children and women of child-bearing age, and the number of measures taken during a scan are limited.

A different technique, called **Magnetic Resonance Imaging (MRI)**, was developed that is non-invasive and does not



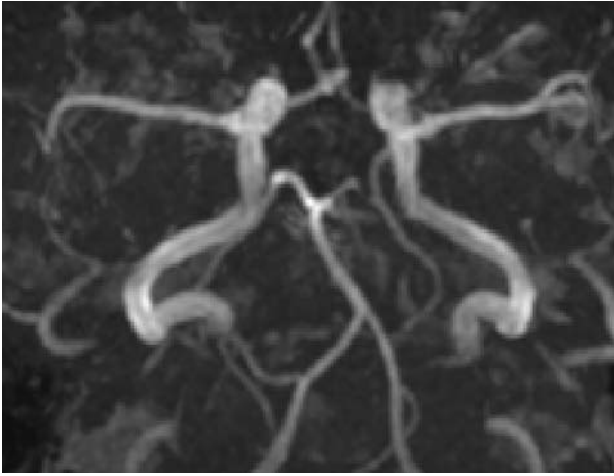

Images of blood vessels in the brain. Changes in blood flow can be detected and serve as an index of neural activity.

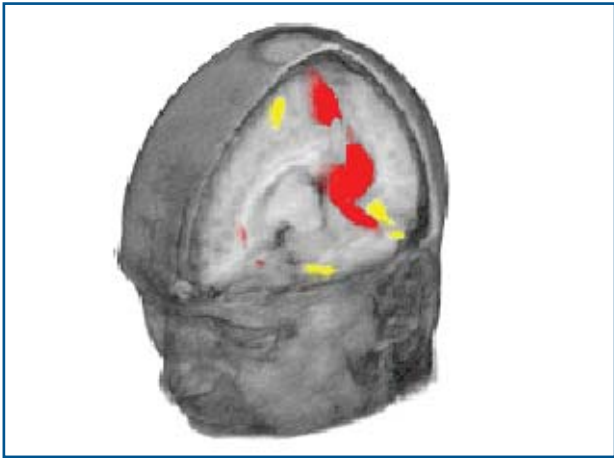

With computer technology, the images obtained by PET and MRI scanners show exactly where the changes in blood flow occur within the brain.

require radioactive substances. This allows people of any age to be scanned. MRI can be used to provide very fine-grained images of brain structure, and a recent development called **diffusion tensor imaging (DTI)** permits detailed images of the white matter tracts of fibres that connect brain regions.

One of the most exciting applications of MRI technology provides images of brain function: this is called **functional Magnetic Resonance Imaging (fMRI)**. This technique is based on the difference in magnetic properties of oxyhaemoglobin and deoxygenated haemoglobin in blood (hence the signal in fMRI is called the **Blood-Oxygenation-Level-Dependent signal - BOLD**). As increased neuronal activity leads to movements of ions that activate energy-requiring ion pumps, there is an increase in energy metabolism and oxygen consumption. This leads to an increase in deoxygenated haemoglobin and a decrease of the magnetic signal. However increased oxygen consumption is followed within seconds by an increase in local cerebral blood flow. The increase in cerebral blood flow exceeds the increase in oxygen consumption; there is therefore a relative increase in oxyhaemoglobin and the size of the signal. The exact mechanism of the increased cerebral blood flow is still unclear, but neurotransmitter-related signalling is now thought to be responsible.

Putting it to use

You're probably pretty good at subtracting numbers. But have you ever tried subtracting brains? No wonder the boy looks confused (cartoon). Subtracting brain images in 2- and 3 - dimensions turns out to be critical for the data analysis. Most fMRI studies involve measuring the BOLD signal while people are engaged in carefully controlled tasks. During a scan, subjects lie within the bore of a magnet, and their behavioural responses to stimuli are monitored. A wide range of stimuli can be presented, either visually, projected onto a screen for the subject to view, or in the auditory domain via headphones. It is possible to examine covert phenomena

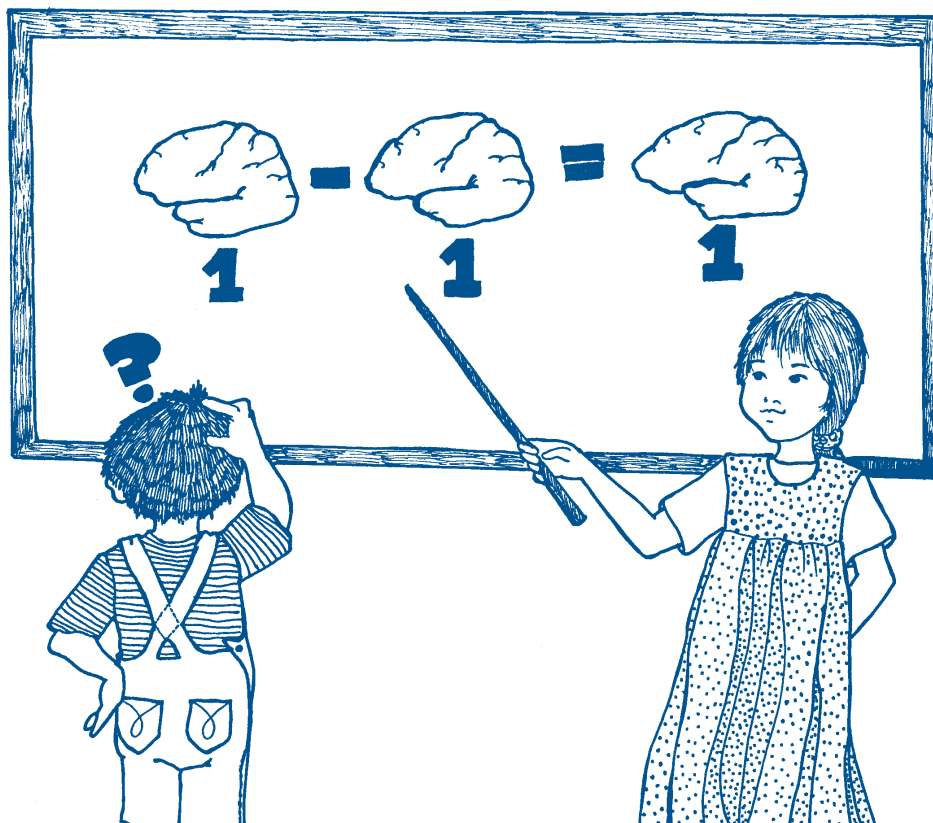

such as perception, learning, remembering, thinking or planning. Often two very similar tasks are designed with one to be done immediately after the other. The idea is that the first task should involve the brain process an experimenter is interested in whereas the other should not. The succession of brain images obtained are then subtracted from each other to yield a pixellated 2D image of what changes in activity are specifically associated with performing the critical brain process. These images are stacked up by the computer to yield an effective subtraction of the image in 3 dimensions (see cartoon previous page). Recent developments mean that even very brief thoughts or brain events (as little as one or two seconds in duration) can be measured. This is known as event-related fMRI. Sophisticated methods of data analysis are used to test whether changes in the signal during performance of a task are statistically reliable. One widely-used analysis package

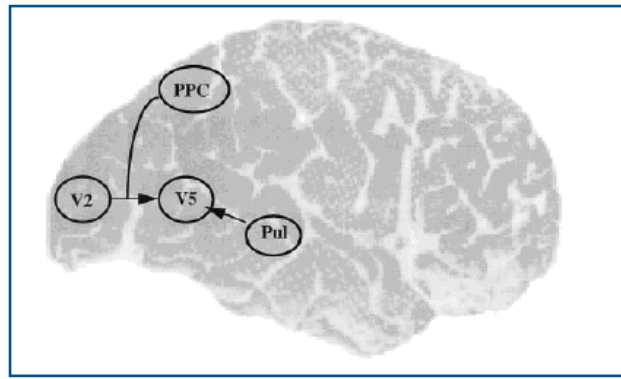

Activation of area V5 reflects the perception of motion. This area's inputs come from V2 of the cortex and the pulvinar (Pul) that is deeper in the brain. The posterior parietal cortex (PPC) controls the flow of information. Effective connectivity analyses enable the relative contributions of these to be worked out.

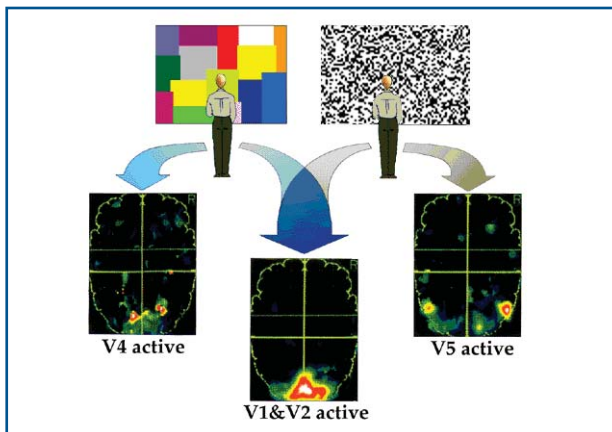

A person in the scanner might be shown a variety of visual images. All of these would 'light up' the primary areas of the visual cortex, V1 and V2. Use of clever subtraction techniques has revealed that colour processing (left) is in area V4, while motion processing (of random dots moving about on a screen - right) activates V5.

that has standardized the processing of imaging data is called statistical parametric mapping (SPM). SPM maps are often given colours, with a fiery yellow used for the 'hottest' areas of activity through to blue and black for 'cooler' areas.

Brain imaging scientists speak of areas 'lighting up' when certain functions are carried out. If a person watches a constantly changing checkerboard pattern, substantial activation is observed in the primary visual cortex. The use of moving and coloured colour patterns and other clever stimuli designed to activate different areas of the visual system has given us a great deal of new information about the organisation of the human visual system. Similar studies have been conducted for other sensory modalities. This localisational way of thinking has also helped to identify the brain areas involved in distinct components of reading - such as transforming visual words into a phonological code, the grouping of phonemes into whole words, the process of extracting the meaning of words, and so on. Learning tasks have also been studied, including work dissociating the brain areas involved in anticipating and perceiving pain.

However, as research has proceeded, various surprises have emerged. One early example was the unexpected failure to

see the medial temporal lobe lighting up routinely in long term memory tasks. However, newer testing paradigms - some including virtual reality - are now revealing its activity in memory processing along with other areas such as the prefrontal cortex and precuneus. Coupled with new neuropsychological and other imaging findings, this diversity of brain areas involved has led to a revision of our understanding of the memory systems of the brain. New mathematical techniques are also being developed to look at how the neural activity of different brain regions interacts and correlates during complex tasks - known as **effective connectivity**. This measure allows us to appreciate how brain areas work as a team and not merely as isolated functional hot spots. The hope is that these new techniques, with magnets of high field strength providing even more precise images, will tell us about the dynamics of networks of neurons talking to each other in the seamless control of perception, thought and action.

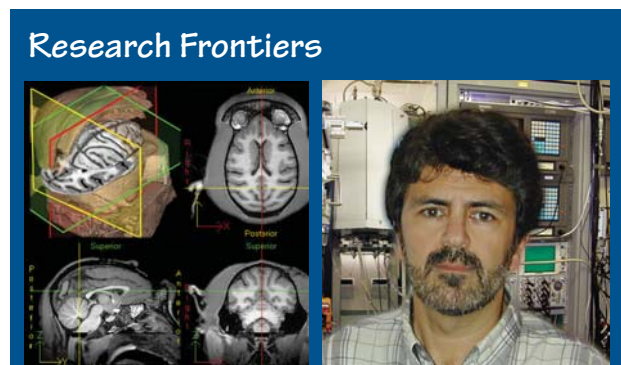

Nikos Logothetis is a young researcher making a major contribution to understanding the relationship between the activity of neurons in the brain and the signals seen in brain-imaging experiments.

Recent experiments in which electrical recording is combined with fMRI have shown a much closer correlation between synaptic activity and the BOLD signal than action potential discharge. The BOLD signal is therefore a more reliable index of synaptic processing within a brain region than its action-potential output. This has important implications for the interpretation of the BOLD signal in terms of localisation of function.



Neural Networks & Artificial Brains

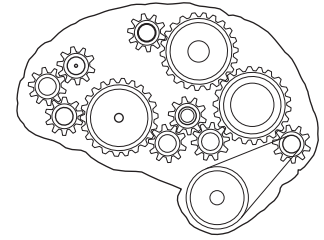

The real brain is squishy stuff. Its neurons, blood vessels and fluid-filled ventricles are made of lipid membranes, proteins and a great deal of water. You can poke the brain with your finger, cut it on a microtome, insert electrodes into its neurons and watch the blood pulsing through it. The study of the brain seems firmly anchored in biology and medicine. However, there's another way of thinking about it that has attracted the attention of mathematicians, physicists, engineers and computer scientists. They think about the brain by writing equations, making computer models and even hardware devices that mimic the real neurons inside our heads.

Real brains are highly adaptable. They are able to do things like read handwriting that we have never seen before and to understand the speech of complete strangers. And they can tolerate things going wrong. They function reasonably well for a life-time even though cells are dying and, even in old age, brains are still capable of learning new tricks. Today's robots are very good at doing the restricted range of tasks for which they have been designed, like building a bit of a car, but much less tolerant when things go wrong.

All real brains consist of highly interconnected **neuronal networks**. Their neurons need energy and the networks need space. Our brain contains roughly 100 billion nerve cells, 3.2 million kilometers of 'wires', a million-billion connections, all packed into a volume of 1.5 litres, but weighing only 1.5 kg and consuming a mere 10 watts. If we tried to build such a brain using silicon chips, it would consume about 10 megawatts, i.e. enough electricity to power a town. To make matters worse, the heat produced by such a silicon brain would cause it to melt! The challenge is to discover how brains operate so efficiently and economically, and to use similar principles to build brain-like machines.

Your brain is 100,000,000,000 cells and 3,200,000 kilometres of wires, with 1,000,000,000,000,000 synaptic connections, all packed into 1.5 litres and weighing 1.5 kg. Yet it consumes only about the same amount of electric power as a night-light!



Building brain circuits in silicon

The **energy cost** of signaling - from one neuron to another - has probably been a major factor in the evolution of brains. About 50-80% of the total energy consumption of the brain is consumed in the conduction of action potentials along nerve fibres and in synaptic transmission. The rest is taken in manufacturing and maintenance. This is as true for the brain of a bee as it is for ours. However, compared to the speed of digital computers, the speed of nerve impulses is very slow - only a few metres per second. In a serial processor like a digital computer, this would make life impossible. Biological brains, however, are constructed as highly parallel networks. Most neurons connect directly to many thousands of others. To do this, the brain exploits its three-dimensional volume to pack everything in - bending the sheets of cells into folds and weaving the connections closely together into bundles. By contrast, making connections between even modest numbers of silicon neurons is limited by the two-dimensional nature of chips and circuit boards. So unlike the brain, direct communication between silicon neurons is severely restricted. However, by exploiting the very high speed of conventional electronics, the impulses from many silicon neurons can be 'multiplexed' - a process of carrying many different messages along the same wire. In this way, silicon engineers can begin to emulate the connectivity of biological networks.

To reduce power but increase speed, neurally-inspired engineers have adopted the biological strategy of using **analogue** rather than **digital coding**. Carver Mead, one of the 'gurus' of silicon valley in California, coined the description 'neuromorphic engineering' to describe the translation of neurobiology into technology. Instead of coding digitally in 0's and 1's, analogue circuits code in continuous changes in voltages, as do neurons in their sub-threshold state (Chapter 3). Calculations can then be done in fewer steps because the basic physics of the silicon devices is exploited. Analogue computation easily provides the primitives of a calculus: addition, subtraction, exponentials and integration, all of which are complicated operations in digital machines. When neurons - whether biological or silicon - compute and make 'decisions' they transmit impulses down axons to communicate the answer to target neurons. Because spike coding is energetically costly, efficient coding maximizes the amount of information represented in a pattern of spikes by reducing what is called **redundancy**. Energy efficiency is also increased by using as small a number of active neurons as possible. This is called **sparse coding** and it provides another important design principle for engineers building artificial neural networks.

A silicon retina

One simple artificial version of a biological network has been built consisting of a silicon retina that captures light and adapts its output automatically to changes in overall lighting conditions. It connects to two silicon neurons that, like real neurons in the visual cortex, have the job of extracting information about the angles of lines and contrast boundaries in the retinal image.

The neurons in this prototype are called **integrate-and-fire neurons** and neuromorphic engineers use them a lot. They get this name because they 'add up' the weighted inputs, coded as voltages that are arriving at their synapses, and only 'fire' an action potential if the voltage reaches a set threshold. The silicon neurons themselves are built of transistors, but instead of using the transistors as switches and driving the voltages to saturation as in conventional digital systems, the transistors are operated in their subthreshold range. In this range, they act more like the cell membranes of real neurons. Additional transistors provide active conductances to emulate the voltage- and time-dependent current flows of real ion channels. This small visual system is a prototype for much more elaborate artificial visual systems that are under development, but even it illustrates how a very noisy real-world input can be processed rapidly to produce a simple decision. It can do what it is designed to do - tell the orientation of a line in a scene - and neuroscientists are already using this simple silicon visual system to test equipment and train students. The most important things about artificial networks is that they operate in the real world, in real time and use very little power.

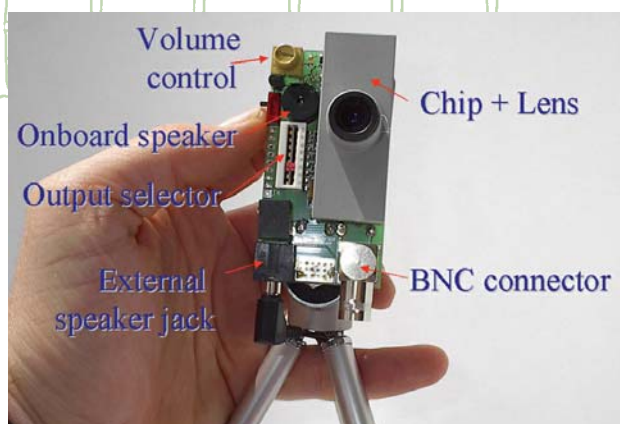

A camera lens is located in front of the silicon retina.

Artificial Neural Networks

Artificial neural networks (ANNs) are often used to study learning and memory. Usually they software on a conventional digital computer, they consist of a number of simple processing units that are highly interconnected in a network. The simplest form of ANN is a **feedforward associator**, which has layers of interconnected input and output units. An associative memory is encoded by modifying the strengths of the connections between the layers so that, when an input pattern is presented, the stored pattern associated with that pattern is retrieved (See **Mathematical Puzzle Box** on the next page). A more complex ANN is a **recurrent neural net**. This consists of a single layer where every unit is interconnected and all the units act as input and output. It sounds a bit strange, but this design enables the net to store patterns rather than merely pairs of items. Decoding this kind of **autoassociative network** is achieved by a recursive search for a stored pattern. It has been shown that for a network of 1000 units, about 150 patterns can be retrieved before errors in the retrieval patterns become too large.

The similarity of ANNs to brains lies in the way they store and process information. The 'knowledge' that they process resides in the network itself. They have no separate memory location like the digital computer, for which the arithmetic processor and memory addresses are separate. Instead, they have **content-addressable storage**. In an ANN, information is stored in the weights of the connections, the same way that synapses change their strength during learning. Nor are ANNs programmed to perform any given procedure. Each 'neuron' inside is 'dumb' and simply responds according to the sum of its weighted inputs. Still, they can be trained to clever things. The **learning rules** that train networks do so by modifying the strength of the connections between the neurons, a common one being a rule that takes the output of the network to a given input pattern and compares it with the desired pattern. Any 'error' in the comparison is then used to adjust the weights of the connections to achieve a closer output to the desired one. The network gradually reduces the error signal to a minimum. This works - but only slowly.

Mistakes turn out to be important - no learning is possible if the network cannot make mistakes. This is a feature of learning that can get overlooked. Over-trained networks that made no errors would end up responding only to one type of input. Such networks are metaphorically called **grandmothered** - a reference to mythical 'grandmother cells' in the human brain that might respond only when one's grandmother comes into view and must never make a mistake! This is not very useful in real world applications because everything we had to learn would require a separate network. On the contrary, the neat thing about ANNs lies in their ability to **generalize** to input patterns they have never been exposed to in training. They see relationships, capture associations and discover regularities in patterns. And they are fault - tolerant just like real brains. They can still retrieve a stored pattern even when the input pattern is noisy or incomplete. These are very important properties for biological brains and ANNs can do these things too.

The paradox of modern computing technology

The paradox of present-day ANNs is that they are simulated mathematically on digital computers. This makes their use in real - world situations much more limited, because the simulation takes time and so the ANNs cannot operate in real time. ANNs might seem well-suited to drive an automobile, or fly an aircraft, because they are robust in the face of noise and keep going when some units in the network cease to work. However, the expert systems that are generally used in automatic pilots are digital computers programmed with conventional deterministic software and, for safety, this always require a backup. If things ever go badly wrong with the aircraft, such expert systems cannot cope. The human pilot must take over. Present-day training algorithms for ANNs are too slow for such emergencies. If silicon neurons could learn, which so far they can't, then many of these problems would fall away. As we learn more about the way in which brains work, we will be able to build more sophisticated neural networks that will provide real brain-like performance.

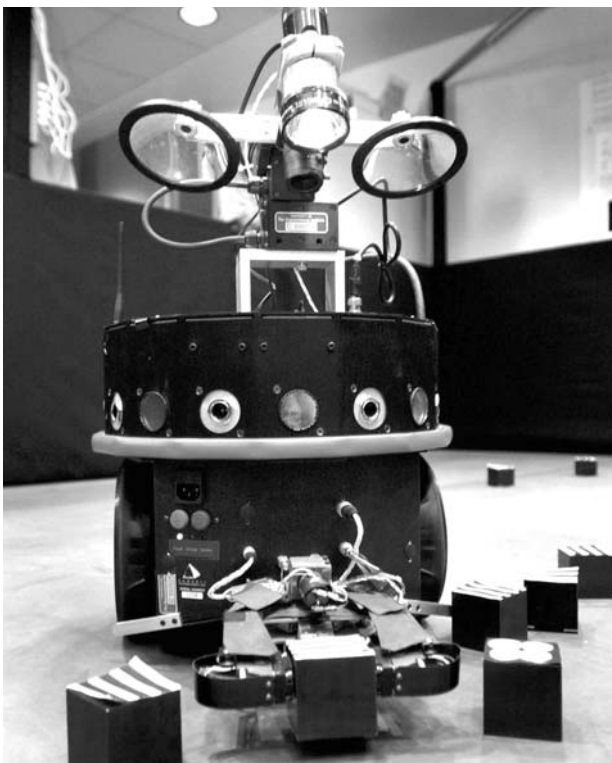

NOMAD is a fidgety yet thoughtful progenitor of thinking machines to come. It stands 2-feet tall with a cylindrically-shaped torso, it has "eyes", "ears", gripper "arms" and other sensors to help it navigate. What makes NOMAD different from most robots is that it operates without coded instructions or rules. Instead, it has a computer-simulated brain with 10,000 simulated brain cells and more than a million connections among them to perceive and react to its environment. It can handle novel situations and learn from its mistakes, as it wanders around in a pen scattered with small painted cubes. Some of the cubes are striped and electrically conductive, making them "tasty". Other cubes are spotted and don't conduct electricity so well, making them less tasty. By looking for cubes and "tasting" them with the electrical sensors on its gripper, NOMAD learns to pass over the spotted cubes and go for the tasty striped ones.



Mathematical Puzzle Box

A Content-Addressable Distributed Memory

Imagine a set of wires running horizontally, intersecting with 4 running vertically, with "switches" at their point of intersection (panel A). This matrix is to be a memory. Information is presented to it in the form of binary numbers, such as 0011 and 1010, and we arrange for the switches to turn on whenever a 1 meets a 1 (B shown in blue). These store the pairing of these two numbers. The matrix can store other numbers on top of the first pair as well, such as 1010 and 0110. The final state of the matrix should have 7 switches on as shown in C. If you now present the first number again - 0011 - to the final state of the matrix and arrange for current to be induced in the vertical wires wherever a switch is on (D), you'll end up with current coming out of the vertical wires at the bottom proportional to the number 2120. This isn't the number that 0011 was first paired with. But, if you divide 2120 by the total number of 1s in the number used as a recall cue (0+0+1+1 which equals 2) using integer division (the type where you forget about the remainder), you end up with 1010. So the matrix has "remembered" that 0011 goes with 1010 even though another message has been stored on top of the first one. You can check this works with the second pair of numbers as well.

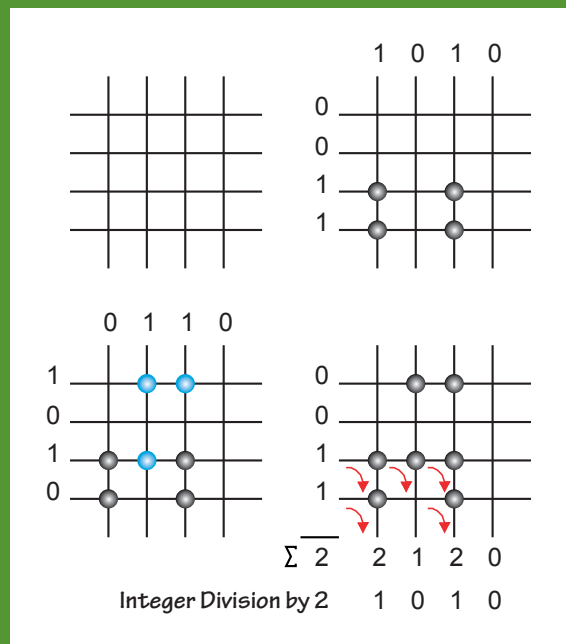

This is the kind of memory we think the brain has. It doesn't store information at specific locations - like in a PC. Information is distributed across the network, stored as changes in synaptic weight, and so can be retrieved with reference to its content. A problem is that this kind of memory gets saturated very quickly, particularly when there are only 4 wires. However, with 1000 pairs of wires, a matrix could store a lot of overlapping pairs of messages without too much interference.



When things go wrong

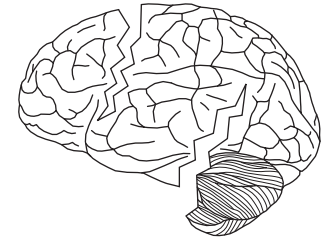

The brain is a delicate organ. Accidents can cause head injury and the brain can become diseased and stop working normally. Diseases of the brain can produce an astonishing range of symptoms and understanding these can be difficult. The assessment of brain disorders requires the clinical skills of the neurologist or psychiatrist at the bedside as well as sophisticated biomedical assays and brain imaging. Research about brain disorders requires an even wider range of expertise. Some disorders, such as epilepsy and depression, are quite common - even in children and teenagers. Others are less common, such as Schizophrenia, or only common in old-age, such as Alzheimer's Disease, but they are no less disabling. Some have a strong genetic component, raising difficult questions about whether each of us would want to know if we had relevant mutations predisposing us to such conditions.

Disorganised signalling – Epilepsy

During a **seizure** (an epileptic fit), the person loses consciousness and may fall to the ground, become stiff and shake. When they come round, they may find that they have bitten their tongue or wet themselves. They may be confused or sleepy afterwards. Many children are affected, but they may go on to have very few attacks later in their life. For some, unfortunately, these can be every week or even every day.

So what is going wrong? During seizures, there is an increase in the firing of action potentials by neurons followed by a period of reduced excitability. This cyclical process is modulated by inhibitory (GABA) and excitatory (glutamate) neurotransmitters. When the reduction in excitability is incomplete, seizures may be triggered by the uncontrolled recruitment of neighbouring neurons. This recruitment may be localised (causing a partial seizure), or may spread to the entire cortex (a generalized seizure). During a **generalised seizure**, the normal alpha rhythm of the electroencephalogram (EEG) is replaced by large, slow, synchronous waves of electrical activity in both cerebral hemispheres (see backdrop).

Isolated seizures are fairly common, but recurring seizures – **epilepsy** – is both less frequent and more troublesome. Its immediate causes are still unclear. In people with epilepsy, attacks may be provoked by tiredness, missed meals, low blood sugar, alcohol, or flickering television screens. Those afflicted have to be careful.

Backdrop shows the EEG during an epileptic fit

Neuroscience research has made two major contributions to improving the lives of people with epilepsy. First, through our developing understanding of excitatory transmission, we can now design drugs that dampen down abnormal seizure activity without damping down normal brain activity. Older drugs tended to act as generalised sedatives, whereas modern ones are much more selective. Second, improvements in the quality of brain imaging means that for some people with severe disabling seizures, it is possible to localise the source of their seizures quite accurately. It is then sometimes possible for a neurosurgeon to cut out this diseased brain tissue with a resulting decrease in seizure frequency and a reduced risk of it spreading to brain tissue that is still unaffected. The surgical management of epilepsy is sometimes thought to be a bit drastic, but it is remarkable how often it works.

Headache and Migraine

Most people experience **headache** at some time. Usually this is caused by muscle tension and is nothing serious to worry about. Very occasionally – especially if the headache comes on very quickly, or is associated with a skin rash or with vomiting – there can be a serious underlying cause. In these conditions the pain comes not from the brain itself, but from irritation or stretching of the **meninges** – the lining of the brain.

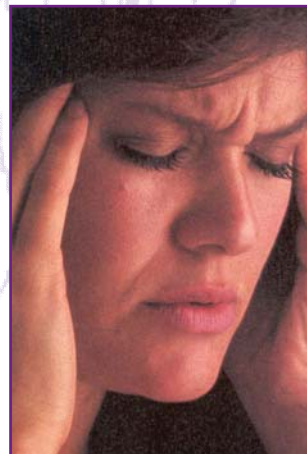

A more common cause of headache is migraine. As well as a sore head (often on one side), people feel sick, find bright lights or loud noises discomforting, and experience a **migrainous aura** consisting of flashing lights or jagged lines. The aura generally precedes the headache.

It now seems likely that migraine starts in the part of the brain that processes pain sensations coming from cerebral blood vessels. Brain imaging reveals increased activity in these regions at the start of a migraine. In response, there is a brief increase in local blood supply (which brings on symptoms like flashing lights), immediately followed by reduced blood flow (reflected in temporary weakness).

The last decade has seen a revolution in the treatment of migraine attacks following advances in our understanding of

serotonin (5-HT) receptors. A new class of drugs was discovered which activated a particular subgroup of serotonin receptors. These drugs – **triptans** – are very effective at stopping a migraine headache in its tracks. This is one of a number of ways in which neuroscience research has made a huge contribution to improving the lives of millions of people around the world.

Not enough fuel – Stroke

When people suddenly develop a weakness down one side of the body, this is usually due to a **stroke** affecting the opposite side of the brain. Balance, sensation or language and speech may also be affected. Sometimes these abnormalities get better with time, even to the point of apparent normality, but stroke is still a very common cause of death and disability. Strokes come in different shapes and sizes, and the consequences depend very much on the part of the brain that is affected.

What has gone wrong has to do with interruption of the **energy supply** that the brain needs to function. Neurons and glia need fuel to work and to survive. That fuel is delivered through the four major blood vessels that supply the brain. The most important fuels are oxygen, and carbohydrate in the form of glucose; together these provide the raw materials to make **ATP** – the energy currency of cells. This energy (see Chapters 2 and 3) is necessary for driving the flow of charged ions that underlie the electrical activity of neurons. About two thirds of a neuron's energy is used to fuel an enzyme called Sodium/ Potassium ATPase which recharges the ionic gradients of sodium and potassium after an action potential has occurred.

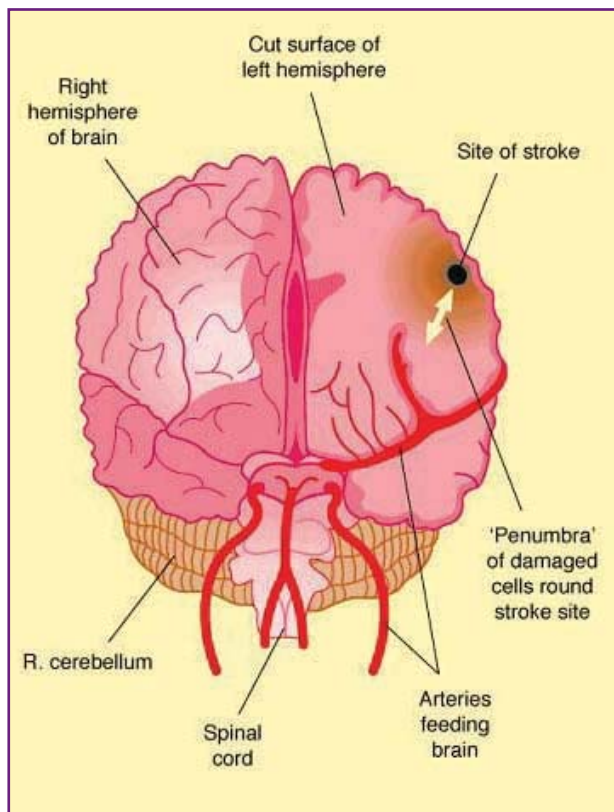

Drawing showing brain damage in a stroke and the penumbral region around that is at risk of damage.

In what is called a **transient ischaemic attack (TIA)**, the blood supply to a part of the brain fails and the supply of ATP is interrupted. Neurons cannot recharge their ionic gradients and so can no longer conduct action potentials. If, for example, the blood supply to the motor cortex of the left hemisphere were to be cut off, the right arm and leg would become paralysed. If the obstruction passes quickly, neurons can again make ATP, recharge their membranes and normal function will resume. Fortunately, no permanent damage occurs in TIA.

A **stroke** is more serious. If the blood supply is cut off for a prolonged period, irreversible damage can occur. In the absence of ATP, cells cannot maintain homeostasis and they may swell up and burst. Neurons may also spontaneously depolarise, releasing potentially toxic neurotransmitters such as glutamate. And glial cells, that normally mop up excess glutamate through an ATP-dependent pump, also stop working. In the absence of energy, the life of a brain cell becomes very precarious.

Through careful study of what happens during a stroke, neuroscientists have been able to develop new treatments. Most strokes are caused by **blood clots** blocking vessels and treatment with a "clot-busting" drug called **tissue plasminogen activator (TPA)** can break up the clot and restore blood flow. Given quickly enough, TPA can have a dramatic effect on the outcome. Unfortunately, getting such a drug to a stroke patient quickly isn't easy as it may not be obvious to a victim's family what is happening.

Another new treatment is a class of drugs that block neurotransmitters including glutamate that accumulate to toxic levels during a stroke. These drugs can either block glutamate receptors themselves or the intracellular signalling pathways that are turned on by glutamate. Many such drugs are in development. Sadly, none has yet had an impact on stroke.

Genetic Diseases

Doctors have long recognised and diagnosed brain disease according to the region affected. For many diseases, the name is a description of what appears to be wrong and the part of the brain involved, often dressed up in Latin or Greek, such as "parietal apraxia". The explosion of genetic information in the last ten years has changed things completely. For many inherited diseases, the problem lies elsewhere.

Some people inherit a problem with the fine control of movements that makes them increasingly unsteady on their feet as the years go by. Called **spinocerebellar ataxia** – a name that reflects the classical history in the naming of diseases – we now know the precise gene defects that cause it. Many other conditions can now be classified according to their cause and diagnostic genetic testing is now routine for patients suspected of spinocerebellar ataxia or other genetic conditions. The diagnosis can be made more quickly and with much greater certainty than before.

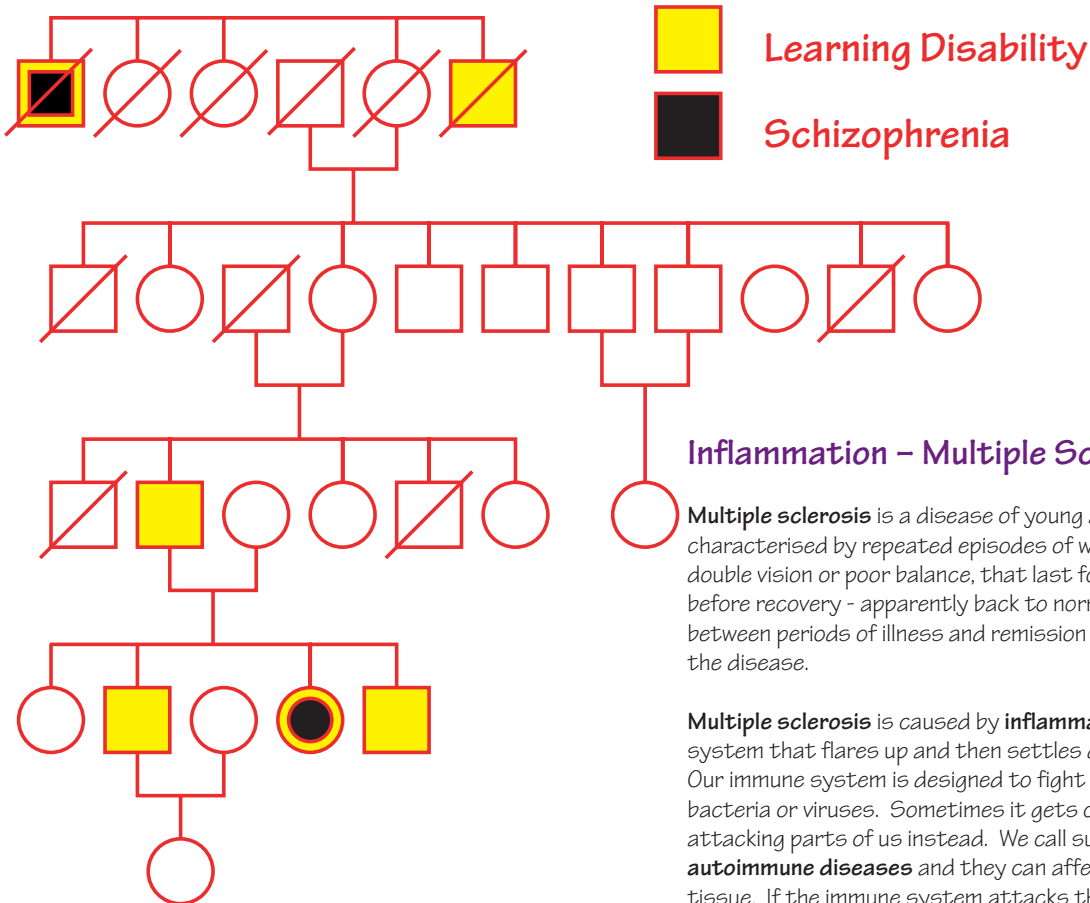

A family tree showing the generations of a family prone to learning disability and schizophrenia. Notice how these afflictions can sometimes skip a generation.

Inflammation – Multiple Sclerosis

Multiple sclerosis is a disease of young adults. It is characterised by repeated episodes of weakness, numbness, double vision or poor balance, that last for a few weeks before recovery - apparently back to normal. The cycle between periods of illness and remission is a feature of the disease.

Multiple sclerosis is caused by **inflammation** in the nervous system that flares up and then settles down again. Our immune system is designed to fight infections caused by bacteria or viruses. Sometimes it gets confused and starts attacking parts of us instead. We call such conditions **autoimmune diseases** and they can affect almost any tissue. If the immune system attacks the **myelin** that wraps around neurons, there will be a local area of inflammation that causes **demyelination**. In time, the inflammation usually settles down, the myelin is repaired, and things return to normal. Quite what sparks off the inflammation in the first place is not clear, and many people with demyelination only ever have one brief episode. However, some people seem to have a tendency to have recurrent bouts affecting different parts of the brain.

Because we do not yet know what triggers inflammation in multiple sclerosis, we cannot completely stop it. However, we now do know that the attacks can be made shorter using drugs such as **steroids** that dampen down the immune system. For patients with severe MS, some doctors believe that permanently dampening down certain parts of the immune system with drugs like **azathioprine** or **β-interferon** can be beneficial. There is still considerable uncertainty about their use.

The immune system can also attack the junctions where nerves connect with muscles, causing a disease called **myasthenia gravis**, or the nerves as they emerge from the spinal cord, resulting in a condition called **Guillain Barré syndrome**.

Huntington's disease is a neurodegenerative disease associated with abnormal involuntary movements of the body - in this case named after the doctor who first described the condition. It is entirely due to a repeat mutation in one of the largest genes in the human genome called **huntingtin**. Some early onset forms of **Parkinson's disease** (a disease causing slowness, stiffness, tremor and unsteadiness) are due to problems in genes coding for **Parkin**. As well as helping with diagnosis, genetic testing can be used to advise other family members about their risks of developing diseases, or passing it on to their children.

However, much as the genetics revolution has changed the way that doctors deal with diseases of the nervous system, it is only the start of a long voyage of discovery. The same gene defect can cause different diseases in different people, and different gene defects can cause very similar diseases. Understanding what it is that defines these differences, and how your genetic makeup interacts with the world in which you live and which you build around you, is one of the next great challenges for the genomic era in which we live.

Discussion Point
 If you discovered you were at risk for developing a genetic disease, would you want to know for sure? Would it be right to identify the gene prior to birth and abort those who would develop the disease? What about all the useful and productive years lived by sufferers before the disease develops?

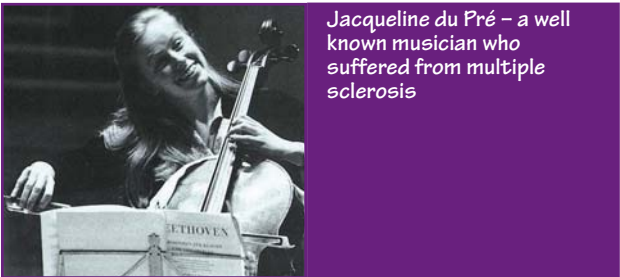

Jacqueline du Pré – a well known musician who suffered from multiple sclerosis

Neurodegeneration – Alzheimer's disease

It is our brains that make us who we are: how we react in different situations, with whom we fall in love, what we fear, what we remember. This fundamental aspect of human nature is laid bare when our brains fail in the progressive disorder known as Alzheimer's Disease. Alzheimer's disease is a form of **dementia** – a global loss of faculties that affects approximately 5% of 65 years olds and 25% of those aged 85 or older. This is a heartbreaking illness: the condition usually starts with memory failure, and progresses to a loss of normal personhood and ultimately death. To watch loved ones lose themselves in this fashion is an exceptionally difficult experience for relatives. Ultimately, sufferers may be unable to recognise those closest to them and will require help with everyday activities such as dressing, eating, bathing and toileting. Consequently, their carer's life is changed dramatically also.

“Dad doesn't know who I am these days. He just doesn't seem to recognise me any more. He gets angry and frightened at the least thing - I don't think he understands what is going on around him. At first, he just seemed to be forgetful, always losing things. Then it got worse. He wouldn't go to bed, didn't seem to know what time it was or even where he was. Now he's lost control of his bowels and needs help to eat and dress. I can't cope.”

What is going wrong? As Alzheimer's disease develops, brain cells die: the cortex thins and the ventricles (the fluid filled spaces in the brain) enlarge. The diagnosis is usually made in life on the basis of the characteristic clinical features, but can only be confirmed definitively at a post-mortem when microscopic examination of the brain reveals the cell loss, and the widespread abnormal deposition of an amyloid protein in scattered small degenerating **amyloid plaques** and a tangled mess of rod-like proteins that are normal constituents of brain cells - **fibrillary tangles**. Current research projects are trying to improve diagnosis in life with new neuropsychological testing procedures focused on distinguishing the mental changes in the earliest stages of Alzheimer's from those in, for example, depression.

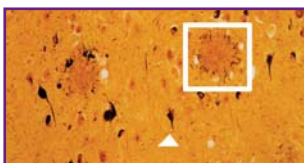

Staining of the brain shows amyloid plaques (e.g. in the rectangle) and the darkly stained tangles (arrow).

Again, genetics has provided a handle to get us started in understanding the disease – pointing to mutations in genes that encode **amyloid precursor protein** (from which amyloid is made) and the **presenilins** (which encode enzymes that break the precursor protein down). Inheritance of a particular variation of the **apolipoprotein E (apoE)** gene designated **apoE-4** is also a major risk factor in the disease. However, genetic factors do not tell the whole story: environmental factors, such as toxins and other insults such as traumatic brain injury, may also play an important role. But genetic factors are sufficiently important that

genetically altered laboratory animals have been bred that show features of the disease. Research on these has to be interpreted very carefully, and not over-interpreted, but they can help us get a grasp on the biology of the disease process.

Treatments that stem the progression of Alzheimer's Disease still do not exist, although they are eagerly sought - and this is where the animal research is so valuable. It is known that nerves cells utilising the chemical transmitter **acetylcholine** are particularly vulnerable to attack in the condition. Drugs that boost the action of the remaining acetylcholine by blocking the effect of enzymes that normally destroy this neurotransmitter have a modest treatment effect in both animal models and some clinical cases. However, these drugs do nothing to slow the progression of this still incurable disease. Drawing together genetic clues, understanding relationships between brain chemistry and psychological function, and learning more about the mechanisms by which cells are damaged seems to be the way forward in ultimately defeating the disorder.

Depressive Disorder

It may come as a surprise to learn that depression and neurodegeneration can be bedfellows – but we now know that severely depressed patients can lose brain cells.



A depressive illness is very different from the low feelings we all experience from time to time. We are dealing with a truly serious medical condition when low mood becomes prolonged for weeks and months. It then begins to take over everything – to the extent that sufferers want to die

and may try to kill themselves. Sufferers display other characteristic symptoms: disturbed sleep, lowered appetite, failing concentration and memory, and a loss of interest in life. Fortunately, it is eminently treatable. **Antidepressant drugs**, which enhance the effects of neuromodulatory transmitters such as **serotonin** and **noradrenaline** can

rapidly (within weeks) treat the illness. Specialised talking treatments are also effective, and a combination of chemical and psychological treatments can be especially helpful. The condition is surprisingly common – 1 in 5 may suffer at some time in their lives from some degree of depressive disorder.



Vincent Van Gogh – the impressionist painter – suffered from severe depression

Being severely and chronically depressed has an unbalancing effect on the control of stress

hormones, such as cortisol, that are beneficially released acutely during stressful situations (Chapter 12). However, when chronically activated, stress hormones may actually damage brain cells, particularly in the frontal and temporal lobes of the brain. It has recently been found that antidepressant drugs promote the integrity of brain cells and increase the rate at which new neurons are produced in the hippocampus. In this way, they may go some way to protect against and even reverse the toxic effects of stress on the brain.

Schizophrenia

Another psychiatric disorder that draws together abnormalities of brain chemistry and brain structure is **schizophrenia**. This is a progressive and potentially very disabling condition that affects 1 in 100. The condition often starts in early adulthood and is said to blight more lives than cancer.

The core symptoms of schizophrenia are **delusions** (abnormal beliefs – commonly bizarre ideas which are often persecutory in nature) and **hallucinations** (disorders of perception where sufferers experience abnormal sensory impressions, such as hearing voices when there is no one there). There is often a progressive decline in cognitive ability, social interaction and ability to work.

The condition is much misunderstood: it has nothing to do with “split personality” with which it is often confused, nor as a rule are sufferers in any way violent. Indeed, most people with schizophrenia are fearful rather than dangerous. There are clearly genetic factors at work in the genesis of the illness, but as with other conditions, environment and stress are also important. Nonetheless, for all the obvious psychological changes, the condition is primarily a brain disease. It has long been known that the ventricles of the brain enlarge in the condition, and that the activity of the frontal lobes becomes impaired.

“At first, we didn’t know what was happening to our daughter, Sue. She had started well at University and coped easily with the exams in her first year. Then she began to change - she became quiet and withdrawn when she was at home, quite unlike her former outgoing self. She stopped seeing friends - later we found she hadn’t been going to classes either and was staying in bed all day. Then one day she told us she had received a special message from the television set saying that she had special powers, and that satellites were controlling her thoughts by telepathy. She laughed for no reason, and then she would cry. Obviously something was very wrong. She said that she could hear voices all around her who spoke about everything she did. It turned out that she was suffering from schizophrenia.

She was in hospital the first time for about two months. Now she takes regular medication. Although she has been much better recently - she doesn’t have strange ideas about satellites any more - she still doesn’t take much interest in things. She had to stop her studies at University and though she worked for a while in a local shop, she had to go into hospital again for a couple of weeks and lost her job. She just isn’t the same person.”

Drugs that block **dopamine receptors** are helpful in reducing the frequency and impact of symptoms, but they do not cure the condition. The latest research suggests that, when activated experimentally using drugs such as amphetamine, it is possible to detect abnormalities in the release of dopamine in people with schizophrenia. There is much more to be discovered about the disorder: post-mortem studies suggest that the way that neurons have connected up during development may be abnormal, and that other neurotransmitter systems, such as glutamate, may be malfunctioning.

Our efforts to understand the nature of mental disorders represents **the last great frontier** for medical neuroscience. Organisations such as the Medical Research Council and the Wellcome Trust have put mental health high on their agenda for research over the next decade. One important current project is capitalising on both genetic knowledge and brain scanning equipment to study the disease prospectively - in families at risk (see Box). Bridging the gaps from “molecules to bedside” remains one of the most challenging research endeavours.

Research Frontiers



Result
 Investigators
 Psychiatrists
 GP's
 Subjects
 High Risk Families

A prospective study of Schizophrenia

Most studies of neurological and psychiatric disease are on people who already have the condition. Researchers in Scotland are using genetic information to study members of families that are at risk of developing the condition. Brain scanning and careful tests of mental function and physical features are being done at regular intervals to see if markers of the incipient development of the disease can be identified. This information could prove very useful in developing new treatments.



Neuroethics

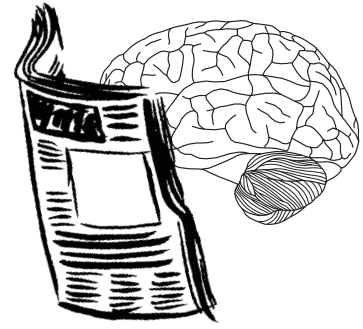

Once upon a time, a very long time ago (as the fairy-tale so often begins), there was a clear distinction between science and technology. Scientists pursued an unbridled path in search of truth, wherever that might lead, for no more reward than the “the pleasure of finding out”. Engineers and technologists applied the fruits of scientific endeavour to change the world in which we live. However beguiling this sharp distinction may seem, it is and always has been a fairy-tale. Nowadays, scientists are ever more aware of the social context in which they work, and how that context can affect what they study.

Questions relating to the impact of neuroscience on society are collected under the general heading of **neuroethics** - the intersection of **neuroscience**, **philosophy** and **ethics**. This includes how discoveries about the brain affect our sense of ourselves as human beings (such as the neural basis of morality). It is about the implications for social policy (such as a child’s educational potential) and how research is itself conducted (such as the ethics of animal experimentation or the use of deception with human subjects). And it is about how neuroscientists should best engage with the public in communicating what they do and sharing idea about what they should be doing.

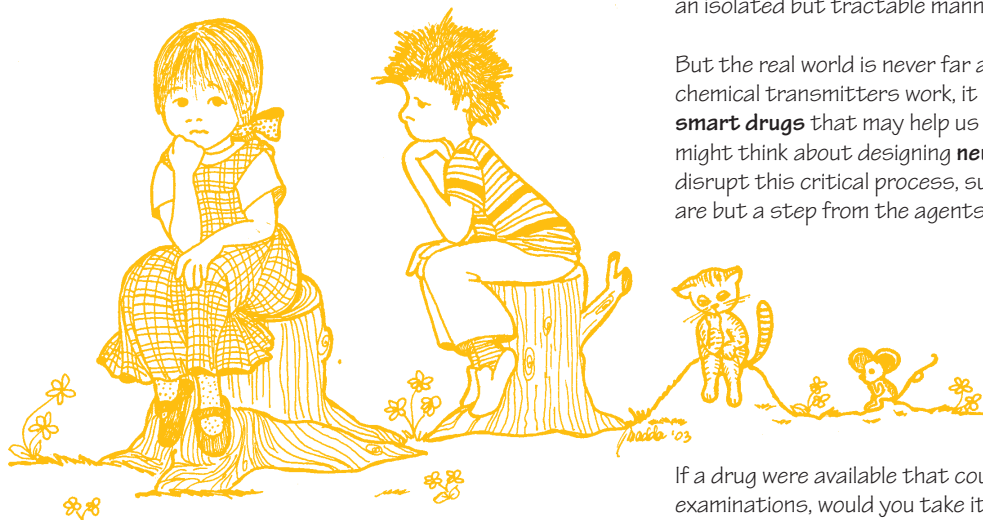

“THINKING ABOUT THE BRAIN TOUCHES US ALL,
IT IS LITERALLY HEADY STUFF”

Zach Hall, University of California

The social context

While some neuroscientists believe that their concepts are divorced from social reality, this is rarely so. In the 17th C, Descartes used a hydraulic metaphor to explain how the “humours” of the brain moved the muscles - a metaphor borrowed from the water engineering he saw in the gardens of French chateaux. At the turn of the 20th C, reflecting the industrial age, neurophysiologists described the intricate wiring of the brain as “an enchanted loom” or later as a giant “telephone exchange”. Now, at the start of the 21st C, computational metaphors abound, such as the fanciful speculation that “the cerebral cortex operates not unlike a private world wide web”. These are partly shorthand to help convey complex ideas, but also concepts that are actually built into sophisticated brain theories.

Neuroscientists can and do engage in thinking about scientific problems divorced from the everyday world. Often this escape is into an abstract, jargon-filled world in which something quite close to a monastic search for truth really is underway. Whether it is working out the ionic currents that underlie the propagation of the action-potential, how chemical messengers are released and act, or how cell-firing in the visual cortex represents aspects of the visual world - many problems in neuroscience can be cast in an isolated but tractable manner.

But the real world is never far away. Once we know how chemical transmitters work, it is natural to think about **smart drugs** that may help us remember better. Some might think about designing **neurotoxins** (nerve agents) that disrupt this critical process, such as enzyme inhibitors that are but a step from the agents of biological warfare.

If a drug were available that could help you pass examinations, would you take it? Is there any difference between this and an athlete using steroids to improve their performance or a person taking an anti-depressant?

Less fanciful ethical dilemmas surround **the future of brain-imaging**. For example, brain-imaging techniques may soon make it feasible, with appropriate testing procedures, to distinguish a person’s real memories from their false ones.

The variability in response is too big just now, but courts may one day have brain-scanning technology at their disposal - a kind of "cerebral fingerprinting" that could help establish the veracity of witnesses. This raises interesting issues about what one might call **cognitive privacy**.

New findings about the brain are all the time revising our **sense of ourselves**. Influential ideas about the evolution of the brain include many related to **social cognition**. There is an emerging awareness that morality and conscience are closely coupled to the emotional brain that processes signals of reward and punishment - a possibility that some have argued under the rubric of **evolutionary ethics**. Learning more about these could be an immense force for good, helping us to be more aware of each other's feelings. Building these ideas into our presently primitive concepts of neuronal plasticity could yet have an impact on education beyond the immediate academic goals that are so often the only focus of discussion.

It is also important to appreciate that neuroscientists do not agree about the future directions of their subject. For some molecular neurobiologists, ultimate truth lies embedded in the molecular constituents of the nervous system - with new DNA and proteomic technologies promising fuller explanations of the brain that will finesse the problems faced by other neuroscientists. This is the **reductionist agenda**, whose full philosophical and technological flowering is so often celebrated in media accounts. But is such a reductionist confidence justified? Or are there higher-level explanations of brain and mind that are not reducible in this way? Are there **emergent properties** arising from the brain's organization? **Interactionist neuroscientists** firmly believe in a different agenda. They argue for a more eclectic approach to modern neuroscience, an approach that explores its interaction with the social sciences as well. These are not issues easily discussed in a public forum, but questions about what sorts of research should be undertaken are matters about which society should be consulted. After all, people's taxes help to pay for it.

Neuroethics - some concrete examples

Certain issues in neuroethics yield to little more than **common-sense**. Suppose a brain scan of a volunteer subject in an experiment was unexpectedly to reveal a cerebral abnormality - such as brain tumour. Or imagine that a subject in a human neurogenetics screen was found to have a mutation that rendered them susceptible to a neurodegenerative disease. In each of these cases - should the subject be told? Common sense suggests that responsibility should be passed to the volunteer who, in advance, would be asked to offer or decline their consent that any relevant medical information discovered in the course of the scan be passed on.

However, **informed consent** is a funny business. Suppose a brain researcher was conducting a trial of a new treatment for stroke in which either the drug or a placebo had, in a blind fashion, to be given within a few hours of the stroke. There are sound scientific reasons for such a randomised protocol. But we cannot anticipate who will suffer a stroke and it may be impossible for the person affected to give informed consent. If this prevents the patient participating

in such a research project, it would be to their long-term detriment and that of later patients. Relatives also may not be in a state of mind where it is easy for them to make a judgement of consent in the time available. Dare we abandon informed consent and introduce waivers, for the greater good? Or is that a slippery slope?

Another important aspect of neuroethics relates to **animal experiments**. Animals are not in a position to offer consent for invasive experiments to be conducted on their brains. To some people, the prospect of such work is disturbing. To others, the opportunity it offers for advancing our understanding of the nervous system in health and disease is such that not to pursue it is irrational. These are not easy issues to debate dispassionately, but it is important that we do - and that we do so respectfully.

In most European countries, animal experiments are regulated in an extremely strict manner. Researchers must attend courses and pass examinations that test their knowledge of the law and their competence in ensuring that unnecessary animal suffering does not occur. There is a widespread acceptance that three Rs - **reduction, refinement and replacement** - are good principles for biomedical scientists to comply with. They do so willingly, within a framework of law, and so command widespread if not unanimous public acceptance. Many new findings in neuroscience are emerging from replacement techniques, such as tissue culture and computational modelling. But these cannot replace all studies of the living brain from which many new findings and treatments for neurological and psychiatric diseases are coming. For instance, the use of L-DOPA to treat Parkinson's disease emerged from Nobel Prize winning work on the rat brain. And new techniques offer new opportunities to help sick people and sick animals.

Only communicate...

It is a puzzling truth that countries in which scientists do most to communicate to the general public tend to be those in which there are lower levels of trust in scientists. But correlation is not the same as cause, and it is unlikely that this responsible effort to engage the public in discussing the impact of science on society - and the growing sense of duty to do so - is the cause of this growing distrust. Rather it is that the interested public is getting more sophisticated, properly more sceptical of new "miracle drugs", and more aware of the slow and sometimes uncertain progress of science. Reducing distrust is no reason to favour a return to blind ignorance.

One reason to engage with young people and the interested public about neuroscience is that neuroscientists still disagree about many of the central tenets of their field. Instead of focusing on isolated discoveries, the media would do well to think more about **science as a process**. A process riddled with uncertainty and debate.

Neuroethics is a new field. There is curious irony that it was Richard Feynman, a theoretical physicist, who described his reason for doing science as being for "the pleasure of finding out". Ironic - because it was Feynman who threw himself headlong into working out why one of the American Space Shuttles, Challenger, exploded soon after take-off. The impact of science on society creeps up on us all.



Training & Careers

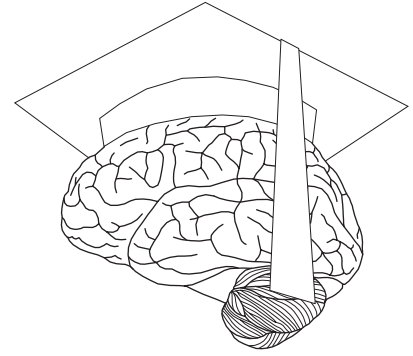

When many young students think of a career in science, it can conjure up images of white coats and laboratories. Hopefully, this booklet will have gone some way to showing that there are many different aspects to neuroscience and that research on the brain will touch peoples' lives in many ways. From the laboratory to the hospital to many other walks of life, there is a diverse range of exciting opportunities within the field.

University Neuroscience Courses

Many universities now offer undergraduate degrees in neuroscience. Often the subject is taken as a specialisation after earlier years training in such subjects as biology, physiology, pharmacology and psychology. A knowledge of genetics and molecular biology can also be valuable.

However, you do not necessarily have to be doing only science subjects in the sixth form to get into some of these courses. Find out about neuroscience courses and their entry requirements by looking at the UCAS pages on the internet. You can look through these by subject or in relation to the universities to which you may be interested in applying.

Medicine

Medicine in Britain is an undergraduate degree. Many universities have Medical Schools and there has recently been an expansion in the number of students being trained through the creation of several new Medical Schools. Specialization in subject areas such as neurology, neurosurgery, psychiatry and radiology comes in the later years of training, but there are often opportunities to work in neuroscience research laboratories during summer vacations and intercalating years. The competition to get into medical courses is considerable, but so are the rewards of a career in medicine.

"The privilege of a job in a University is the intellectual freedom. No day is the same. Every day you learn something new, every day you are stretched and challenged"

Maria Fitzgerald, Professor in London University.

"The appeal was, and still is, the prospect of finding out, being pleasantly surprised by discoveries, and the small leaps of insight that result"

Richard Ribchester, Neurophysiologist in the University of Edinburgh

Rosamund Langston,
Neuroscience PhD
student at Edinburgh University



"I studied sciences and English at A-level and then went on to study biological sciences in Edinburgh. I specialised in Neuroscience in my final year and really found my niche. I was lucky enough to be offered a position as a research assistant in the Cognitive Neuroscience department of Edinburgh University and this eventually lead to a PhD."

Thomas Petty,
Medical student
at Edinburgh University



"I have been set on medicine as a career ever since school and I applied to Edinburgh because of its good reputation. In third year I was given the opportunity to do an intercalated Bsc course and I chose to study Neuroscience. The year gave me an opportunity to study the core research behind the medicine and I took a great deal from it and really enjoyed it."



Industry (Pharmaceutical Industry)

New medicines are constantly being discovered and developed and the brain is a critical target for drug treatment. Pharmaceutical companies, as well as financially supporting academic institutions, conduct their own research. Many co-operate with universities to offer years in industry to help develop laboratory skills and experience. Graduates from a variety of biomedical science courses including neuroscience make desirable employees, particularly when they have had associated laboratory experience.

Neuroscience Research

There are a huge variety of opportunities in research. The field has many elements ranging from brain-imaging and behavioural studies through to neurophysiology and molecular-genetic research. Researchers within universities are always happy to encourage keen students to find a path of academic study that suits them.

Computing Industry

Neuroscience may not spring to mind as a subject to do at university if you are interested in a career in computing or information technology. Still, as we have seen in the booklet, there is growing interest in 'brain-style' computing and this is set to grow with the development of the world-wide web. There is increasing interest in non-medical applications of brain science.

School Teaching

Neuroscience is not taught as a subject in schools. However, graduates with a degree in neuroscience will be well placed to teach biology and will have many other skills, including numerical skills, that would be invaluable in a teaching career.

Science and the Media

From journalism to radio and television, a career in the media is competitive and demanding. However, many opportunities to enter the field of science communication are available. Science is continually advancing and new findings need to be reported for the purposes of both education and public interest. Work on brain research is no exception. There is huge social interest, well recognised by the media, and the latest findings have the potential to have considerable social impact. With a good scientific background and understanding of research, obtained while doing a university degree, it would be much easier to communicate complex findings accurately and effectively both with other scientists and the public.

Science and art

Science and art are not mutually exclusive. Design which captures the imagination is crucial in the presentation of science to a wider audience. Museums, galleries and the media, and other organisations encourage and fund creative, experimental collaborations between scientists and artists.

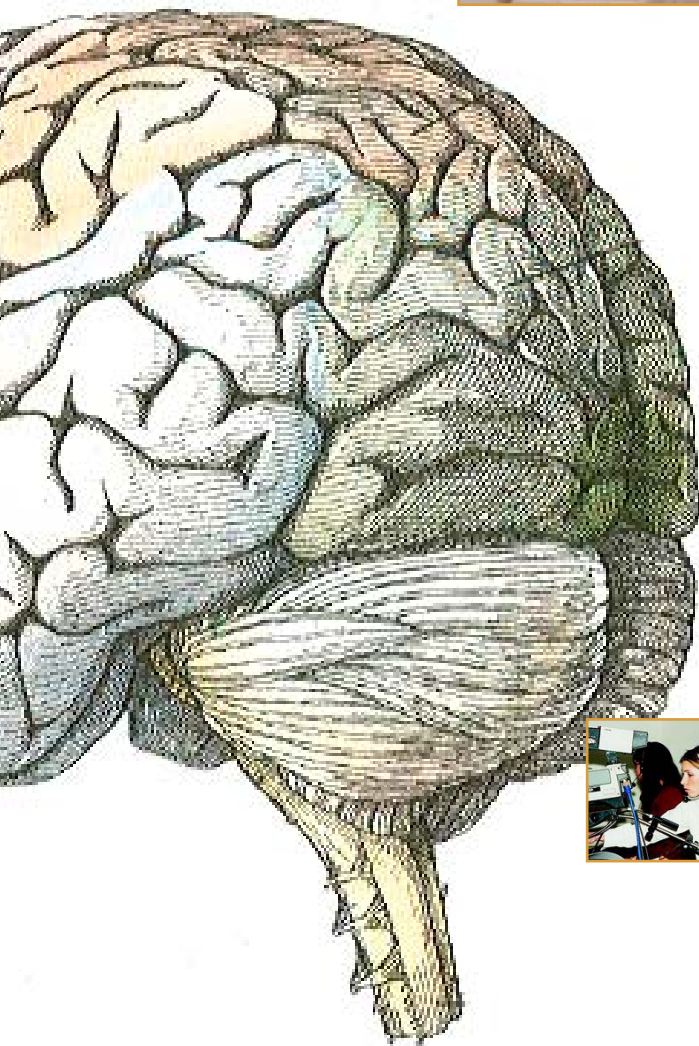

Acknowledgements

We are indebted to many people who kindly contributed text and diagrams that are included in this booklet. We hope the list below is inclusive and apologise to anyone who has helped us but whose contribution has slipped through the net.

Cartoons throughout the booklet: Maddelena Miele and Robert Filipkowski. Front cover illustrations: Peter Brophy, Beverley Clark, Michael Hausser, David Linden, Richard Ribchester. Inside front cover: Peter Somogyi, Elaine Snell, Lisa Cokayne-Naylor. Ch 1 (The nervous system): Marina Bentivoglio, Nobel Forum. Ch 2 (The action potential): Tobias Bonhoeffer, Peter Brophy, Eric Kandel, Nobel Forum. Ch 3 (Chemical messengers): Marianne Fillenz, Ch 4 (Drugs and the brain): Leslie Iversen. Ch 5 (Touch and pain): Susan Fleetwood-Walker, Han Jiesheng, Donald Price. Ch 6 (Vision): Colin Blakemore, Andy Doherty, Bill Newsome, Andrew Parker. Ch 7 (Movement): Beverley Clark, Tom Gillingwater, Michael Hausser, Chris Miall, Richard Ribchester, Wolfram Schultz. Ch 8 (The developing nervous system): Andrew Lumsden. Ch 9 (Dyslexia): John Stein. Ch 10 (Neuronal plasticity): Graham Collingridge, Andrew Doherty; Kathy Sykes. Ch 11 (Learning and Memory): Ted Berger, Livia de Hoz, Graham Hitch, Eleanor Maguire, Andrew Doherty, Leslie Ungerleider, Fareneh Vargha-Khadem. Ch 12 (Stress): Jonathan Seckl. Ch 13: (Brain and Immune System): Nancy Rothwell. Ch 14 (Sleep and Rhythms): Anthony Harmar. Ch 15 (Brain Imaging): Mark Bastin, Richard Frackowiak, Nikos Logothetis, Eleanor Maguire, Lindsay Murray, Elisabeth Rounis, Semir Zeki. Ch 16 (Neural Networks and Artificial Brains): Rodney Douglas, Gerry Edelman, Jeff Krichmar, Kevan Martin. Ch 17 (When things go wrong): Malcolm Macleod, Eve Johnstone, Walter Muir, David Porteous, Ian Reid. Ch 18 (Neuroethics): Colin Blakemore, Kenneth Boyd, Stephen Rose, William Saffire. Ch 19 (Careers) Yvonne Allen (BNA), Victoria Gill. Inside back cover illustration: Eric Kandel (for Hippocrates Quotation), Richard Morris.

Back cover illustration and words: Jennifer Altman, David Concar; Spike Gerrell.

The British Neuroscience Association is a non-profit making body and is registered as a charity No. 264450.

Further Reading

There are many fascinating books available for continued reading about science and neuroscience. Here is a list of a few of them:

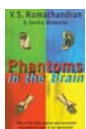

V.S. Ramachandran, (Sandra Blakeslee) **Phantoms in the Brain: Human Nature and the Architecture of the Mind**
Fourth Dimension Publications
(Paperback - 6 May, 1999) ISBN: 1857028953
A fascinating account of phantom-limb pain and related disorders of the nervous system.



Oliver Sacks, **The Man Who Mistook His Wife for a Hat (Picador)**
Picador
(Paperback - 7 November, 1986) ISBN: 0330294911
An amusing and well-written account of the effects of brain damage on the mind.



Jean-Dominique Bauby, **The Diving-bell and the Butterfly**
Fourth Estate
(Paperback - 7 May, 2002) ISBN: 0007139845
A very personal and moving account of the consequences of a stroke.



Richard P. Feynman, **Surely You're Joking, Mr Feynman: Adventures of a Curious Character**
Paperback
19 November, 1992 ISBN: 009917331X
Physicist, bongo-drum man, and all round polymath. A hero for all young scientists.



Nancy Rothwell, **Who Wants to Be a Scientist?: Choosing Science as a Career**
Smudge (Illustrator) Cambridge University Press
(Paperback - 19 September, 2002) ISBN: 0521520924
Sound practical advice on choosing science as a career.

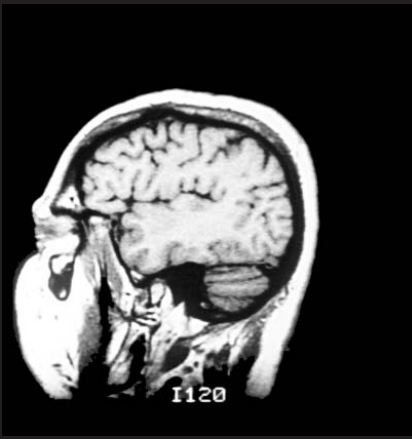

“Men ought to know that from the brain, and from the brain only,
arise our pleasures, joys, laughers and jests,
as well as our sorrows, pains, griefs and fears.
Through it, in particular, we think, see,
hear and distinguish the ugly from the beautiful,
the bad from the good,
the pleasant from the unpleasant”

Hippocrates- 5th Century B.C.

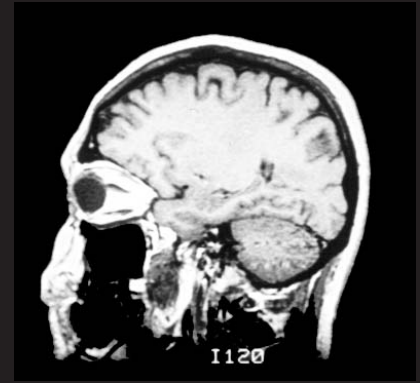
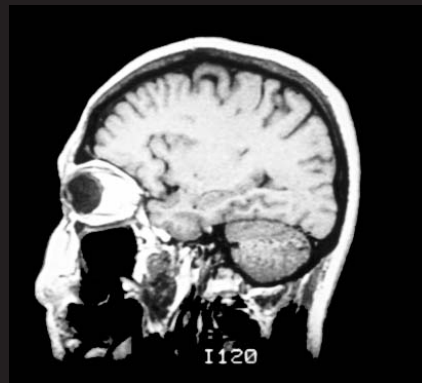
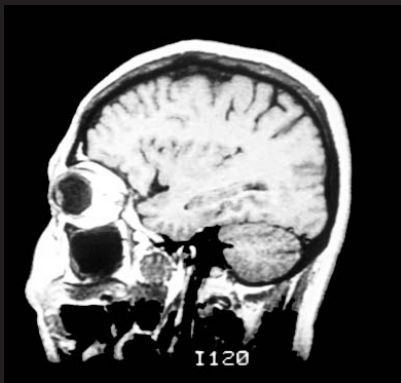

Financial Support

This project was supported by the British Neuroscience Association, Neurology & GI Centre of Excellence for Drug Discovery, GlaxoSmithKline and the Centre for Neuroscience of the University of Edinburgh. The authors are grateful for their generous support.



INTO THE BRAIN

CEREBRAL CORTEX

A THIN SHEET OF NEURONS WHICH ORGANISES PERCEPTION AND CONSCIOUS THOUGHT. IT STORES INFORMATION AND GENERATES PLANS OF ACTION. IF ALL ITS FOLDS WERE IRONED OUT IT WOULD HAVE THE AREA OF A TENNIS COURT.

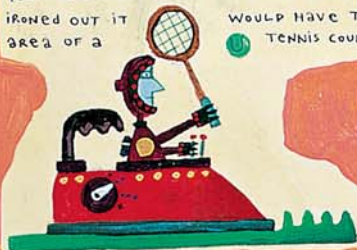

VISION: VISUAL MESSAGES FLOW OUT OF LIGHT SENSITIVE CELLS IN THE RETINA AT THE BACK OF THE EYES, ALONG THE OPTIC NERVE, AND ARE PROCESSED IN A SPECIAL VISION CENTRE AT THE BACK OF THE BRAIN - THE PRIMARY VISUAL CORTEX.

THE VISUAL SYSTEM CONSTRUCTS THE IMAGE OF THE BIRD BY PROCESSING THE INFORMATION ABOUT ITS SHAPE, COLOUR AND DEPTH IN SEPARATE

PATHWAYS. THE BRAIN HAS A FOURTH VISUAL PATHWAY WHICH HANDLES INFORMATION ABOUT MOVING OBJECTS.

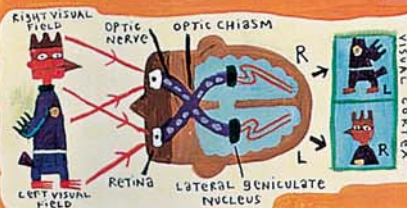

CELLS AND SYNAPSES

THE HUMAN BRAIN CONTAINS ABOUT 10^{11} NEURONS - MORE CELLS THAN THERE ARE STARS IN THE MILKY WAY - WIRED INTO STRUCTURES THAT CAN STORE AND PROCESS INFORMATION. SUPPORTING THESE NEURONS ARE GLIAL, OR 'GLUE' CELLS.

MOST NEURONS RECEIVE MESSAGES THROUGH A BUSH OF BRANCHES, OR DENDRITES, AND SEND ELECTRICAL PULSES DOWN LONG FIBRES CALLED AXONS, CAUSING SUBSTANCES KNOWN AS NEUROTRANSMITTERS TO BE RELEASED AT TINY JUNCTIONS - SYNAPSES. DIFFERENT NEUROTRANSMITTERS STIMULATE

NEURONS IN DIFFERENT WAYS. MOST BRAIN DRUGS ACT BY BLOCKING OR BOOSTING NEUROTRANSMITTERS.

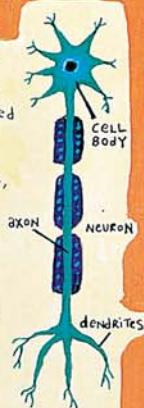

SOMATOSENSORY CORTEX

PROCESSES SENSATIONS OF TOUCH AND PAIN. TOUCH SENSATIONS FROM DIFFERENT PARTS OF THE BODY ARE REPRESENTED IN DIFFERENT AREAS OF THE SOMATOSENSORY CORTEX AS A 'HOMUNCULUS' (LITTLE MAN). HIS PROPORTIONS REFLECT THE SENSITIVITY OF THE BODY PARTS.

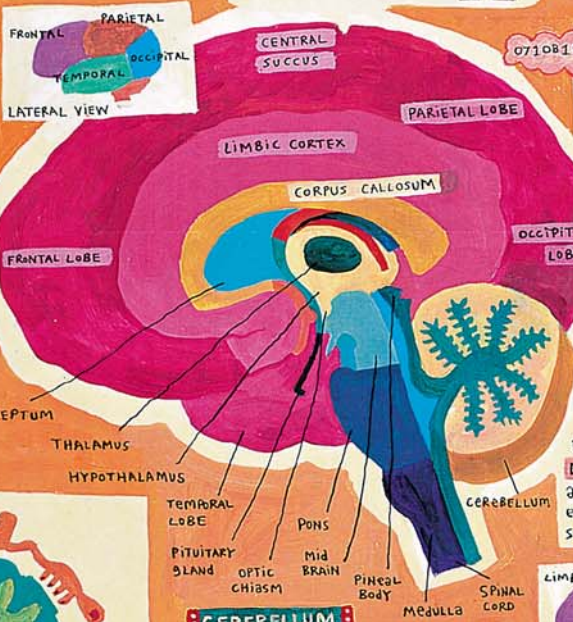

MEMORY



MEMORY IS A COLLECTION OF DIVERSE TALENTS - FACTS, EVENTS, FACES, SKILLS. EACH FORM SEEMS TO BE LOCATED IN A DIFFERENT BRAIN AREA. **WORKING MEMORY** ENABLES US TO HOLD FLEETING MATERIAL IN OUR HEADS FOR DOING COMPLEX TASKS LIKE BUILDING AND UNDERSTANDING SENTENCES. THE FRONTAL LOBES ARE ESSENTIAL. **DECLARATIVE MEMORY** IS KNOWLEDGE ABOUT LANGUAGE, THE WORLD, PAST EXPERIENCE... AND HOW TO DO MATHS. SETTING IT UP REQUIRES THE HIPPOCAMPUS

(AND OTHER LIMBIC STRUCTURES) BUT THE FACTS SEEM TO BE HELD IN THE CORTEX.

CEREBELLUM

CONTROLS MOVEMENT AND POSTURE BY ADJUSTING THE OUTPUT OF THE MOTOR SYSTEM. IT IS INVOLVED IN EYE MOVEMENTS, IN PLANNING LIMB MOVEMENTS AND IN LEARNING MOTOR SKILLS.

MOVEMENT

THE MOTOR CORTEX PLANS ALL OUR MOVEMENTS. IT COMMUNICATES WITH THE CEREBELLUM TO FINE-TUNE MOVEMENT AND WITH THE MYSTERIOUS BASAL GANGLIA. ONE JOB OF THE BASAL GANGLIA MAY BE TO ORGANISE THE ORDER IN WHICH WE MAKE SEQUENCES OF MOVEMENTS. TO MAINTAIN POSTURE, MESSAGES FROM THE SKIN, MUSCLES, INNER EAR AND EYES ARE ALL COMBINED IN THE BRAIN STEM. THE MOTOR CORTEX COORDINATES THE OPERATION.

BASAL GANGLIA

A POORLY UNDERSTOOD COMPLEX OF CENTRES WITH MULTIPLE CONNECTIONS TO THE CORTEX AND LIMBIC SYSTEM. IT IS INVOLVED IN SKILLED MOTOR RESPONSES AND MAKING THE BRAIN FEEL GOOD

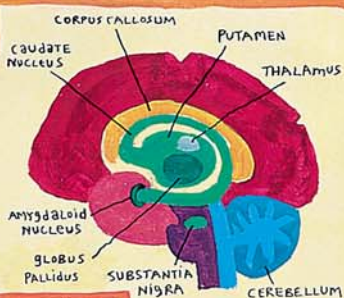

ADAPTED FROM "THE SECRET LIFE OF THE BRAIN" PUBLISHED BY:-

NEW SCIENTIST.

SPIKE GERRELL.